



**TBS2000B Series Oscilloscopes  
User Manual**







**TBS2000B Series Oscilloscopes  
User Manual**

Copyright © Tektronix. All rights reserved. Licensed software products are owned by Tektronix or its subsidiaries or suppliers, and are protected by national copyright laws and international treaty provisions. Tektronix products are covered by U.S. and foreign patents, issued and pending. Information in this publication supersedes that in all previously published material. Specifications and price change privileges reserved.

TekVPI and e\*Scope are registered trademarks of Tektronix, Inc.

TEKTRONIX and TEK are registered trademarks of Tektronix, Inc.

### **Contacting Tektronix**

Tektronix, Inc.  
14150 SW Karl Braun Drive  
P.O. Box 500  
Beaverton, OR 97077  
USA

For product information, sales, service, and technical support:

- In North America, call 1-800-833-9200.
- Worldwide, visit [www.tek.com](http://www.tek.com) to find contacts in your area.

---

# Table of Contents

TEKTRONIX SOFTWARE LICENSE AGREEMENT .....	vii
Important safety information .....	xiii
General safety summary .....	xiii
Symbols and terms on the product .....	xvii

## Installation

Before installation .....	1
---------------------------	---

## Upgrade license

To install option upgrade licenses .....	5
--	---

## Preface

Key features .....	9
Bandwidth options for TBS2000B .....	10
Conventions used in this manual .....	10

## Operating requirements

Environment requirements .....	11
Power requirements .....	11

## Getting acquainted with the oscilloscope

Powering the oscilloscope .....	13
Changing the user interface language .....	15
Changing the date and time .....	19
Connecting probes to the oscilloscope .....	22
Supported probe types .....	23
Reducing electrostatic damage while taking measurements .....	24
Doing a functional check .....	24
What is AutosetQuery .....	27
Compensating a passive voltage probe .....	28
Probes and ground leads tip .....	31
Signal path compensation SPC .....	32
Getting on-screen help for settings - Help Everywhere .....	33
The Scope Intro function .....	36

## Oscilloscope concepts

Sampling and acquisition concepts .....	37
Acquisition mode concepts .....	39
Trigger concepts .....	40
Trigger slope and level concepts .....	42
Available trigger types .....	44
Trigger coupling .....	45
Trigger modes .....	45
Auto Untriggered Roll trigger mode .....	45
Normal trigger mode .....	46
Holdoff trigger mode .....	46
Trigger delay acquisition mode .....	46

## Setting channel input parameters

Setting input signal coupling .....	47
Inverting the input signal .....	48
Setting the oscilloscope bandwidth .....	49
Setting the probe type voltage or current .....	50
Setting the probe attenuation factor .....	51
Quickly setting the probe attenuation to 1X or 10X .....	52
Setting the measure current mode for voltage probes .....	53
Setting the input signal vertical offset .....	54
Setting the waveform vertical position .....	55
The difference between vertical position and vertical offset .....	56
Setting channel deskew .....	57
Deskew tips .....	58

## Trigger setup

Triggering on a waveform edge .....	60
Triggering on a specified pulse width .....	62
Triggering on a runt pulse .....	63
Setting the trigger mode .....	65

## Acquisition setup

Using Autoset .....	67
Autoset tips .....	69

How to enable/disable Autoset in the oscilloscope .....	70
How to change the Autoset password .....	71
Starting and stopping an acquisition .....	73
Setting the acquisition mode .....	74
Setting the acquisition trigger delay time .....	75
Setting the record length .....	77
Using the roll display mode .....	78
Roll mode tips .....	79
Setting the oscilloscope to factory default values - Default Setup .....	80

## Waveform display settings

Displaying and removing a waveform .....	81
Setting the waveform persistence .....	82
Waveform persistence tip .....	83
The XY display mode .....	84
XY display mode tips .....	86
Setting the backlight intensity .....	87

## Analyzing a waveform

Taking automatic measurements .....	89
Automatic measurements tip .....	90
Taking a measurement snapshot .....	91
Snapshot measurement tip .....	92
Automatic measurement descriptions .....	92
Frequency measurement descriptions .....	92
Time measurement descriptions .....	94
Amplitude measurement descriptions .....	96
Area measurement descriptions .....	98
Taking a measurement on just a part of the waveform Gating .....	99
How to enable / disable measurement in the oscilloscope .....	100
How to change the measurement password .....	101
Using cursors to take manual measurements .....	103
Cursor types .....	106
How to enable / disable cursor in the oscilloscope .....	107
How to change the cursor password .....	108
Creating math waveforms .....	110
Math waveform tips .....	111
Using FFT to see signal frequency information .....	112

FFT tips .....	116
About FFT windows .....	116
FFT and display waveform aliasing .....	119
Displaying reference waveforms .....	120
Reference waveform tips .....	120
How to view long record length waveforms Zoom .....	121
How to search and mark a waveform .....	122
How to pan a waveform .....	125

## Feature enable

Disable autose in the oscilloscope .....	127
Disable cursor in the oscilloscope .....	127
Disable measurement in the oscilloscope .....	127

## Saving data

Saving screen images to a file .....	129
About saved image file formats .....	130
Saving waveform data .....	130
About waveform data files .....	131
Saving oscilloscope setup information .....	132
Saving files to USB with the Save File button .....	133

## Recalling data

Recalling oscilloscope setup information .....	135
Recalling waveform data .....	136

## Using the USB file utility functions

Overview of the File Utility pane .....	139
Changing the default file save location on the USB drive .....	141
Default save folder location rules .....	141
Creating a new folder on the USB drive .....	142
Folder creation tip .....	143
Deleting files or folders from the USB drive .....	143
Renaming files or folders on the USB drive .....	144
File folder renaming tip .....	145
Formatting the USB drive .....	145
About automatically generated file names .....	146



Image setting and waveform file tips .....	146
--	-----

## Erasing data from oscilloscope memory (TekSecure)

### Setting or viewing USB Device port parameters

Selecting which device is attached to the USB Device port .....	149
Disabling the USB Device port .....	150
Viewing the USBTMC information .....	150

### Setting up the LAN network

Viewing the IP address - Ethernet .....	153
Setting the IP address DHCP network- Ethernet .....	154
Setting the IP address nonDHCP network- Ethernet .....	155
Turning Ethernet DHCP on or off .....	156

### Setting up the Wi-Fi network

Turning Wi-Fi on or off .....	157
Viewing Wi-Fi settings .....	158
Viewing and selecting available Wi-Fi networks .....	158
Setting the IP address (nonDHCP) network in Wi-Fi .....	159
Setting the IP address DHCP network in Wi-Fi .....	160
Turning DHCP on or off Wi-Fi .....	161

### Connecting your oscilloscope to a computer

Using a socket server .....	163
-----------------------------	-----

## Appendices

Remotely controlling the oscilloscope from a Web browser e*Scope .....	165
Installing new firmware on the oscilloscope .....	166
Running diagnostic tests .....	167
Courseware on-instrument education and training .....	168
Courseware file content information .....	169
Loading a courseware file from a USB drive .....	169
Dealing with error message .....	170
Running Courseware lab exercises .....	170
Saving Courseware lab results .....	172

The oscilloscope controls .....	172
The Navigation controls .....	172
The Horizontal controls .....	174
The Trigger controls .....	175
The Vertical controls .....	176
The Resources controls .....	177
Other front-panel controls .....	177
Using the menu system .....	179
Front-panel connectors .....	182
Rear-panel connectors .....	183
The graphical user interface elements .....	184
Labeling channels .....	192
Warranted specifications .....	194
The default oscilloscope settings Default Setup .....	194
Oscilloscope settings that are not reset by Default Setup .....	195
Physically securing the oscilloscope .....	196
Environmental considerations .....	196
Product end-of-life handling .....	196
Equipment recycling .....	196

---

# TEKTRONIX SOFTWARE LICENSE AGREEMENT

This End User Agreement (“Agreement”) is an agreement between Tektronix, Inc., an Oregon corporation, and its corporate affiliates, subsidiaries, and divisions as applicable (collectively, “Tektronix,” “we,” “us,” or “our”) and You (including any entity or organization you represent, collectively, “Customer” or “You”). Please read this Agreement carefully as this Agreement governs the terms and conditions under which You are permitted to use Tektronix’s software and services.

THE SOFTWARE, ENCODED OR INCORPORATED WITHIN EQUIPMENT OR ACCOMPANYING THIS AGREEMENT, IS FURNISHED SUBJECT TO THE TERMS AND CONDITIONS OF THIS AGREEMENT. BY INDICATING YOUR ACCEPTANCE OF THESE TERMS BY SELECTING AN "ACCEPT" OR SIMILAR BUTTON IN A SOFTWARE MENU, OR BY RETAINING THE SOFTWARE FOR MORE THAN THIRTY DAYS OR USING THE SOFTWARE IN ANY MANNER YOU (A) ACCEPT THIS AGREEMENT AND AGREE THAT YOU ARE LEGALLY BOUND BY ITS TERMS; AND (B) REPRESENT AND WARRANT THAT: (I) YOU ARE OF LEGAL AGE TO ENTER INTO A BINDING AGREEMENT; AND (II) IF YOU ARE A REPRESENTATIVE FOR A CORPORATION OR OTHER LEGAL ENTITY, YOU HAVE THE RIGHT, POWER, AND AUTHORITY TO ENTER INTO THIS AGREEMENT ON BEHALF OF SUCH ENTITY AND BIND SUCH ENTITY TO ITS TERMS. IF YOU DO NOT AGREE TO THE TERMS OF THIS AGREEMENT, TEKTRONIX WILL NOT AND DOES NOT LICENSE THE SOFTWARE TO YOU AND YOU MUST NOT DOWNLOAD, INSTALL, OR USE THE SOFTWARE. UNITED STATES GOVERNMENT CUSTOMERS OR END-USERS MAY REQUEST A GOVERNMENT ADDENDUM TO THIS AGREEMENT.

NOTWITHSTANDING ANYTHING TO THE CONTRARY IN THIS AGREEMENT OR YOUR ACCEPTANCE OF THE TERMS AND CONDITIONS OF THIS AGREEMENT, NO LICENSE IS GRANTED (WHETHER EXPRESSLY, BY IMPLICATION, OR OTHERWISE) UNDER THIS AGREEMENT TO ANY SOFTWARE THAT YOU DID NOT ACQUIRE LAWFULLY OR THAT IS NOT A LEGITIMATE, AUTHORIZED COPY OF TEKTRONIX’S SOFTWARE. THIS AGREEMENT EXPRESSLY EXCLUDES ANY RIGHTS CONCERNING SUCH ILLEGITIMATE COPIES.

IF THESE TERMS ARE NOT ACCEPTABLE, THE UNUSED SOFTWARE AND ANY ACCOMPANYING DOCUMENTATION SHOULD BE RETURNED PROMPTLY TO TEKTRONIX (WITHIN 30 DAYS OF PURCHASE) FOR A FULL REFUND OF THE LICENSE FEE PAID. (FOR INFORMATION REGARDING THE RETURN OF SOFTWARE ENCODED OR INCORPORATED WITHIN EQUIPMENT, CONTACT THE NEAREST TEKTRONIX SALES OFFICE.)

## **DEFINITIONS**

“Equipment” means Tektronix equipment that the Software is encoded or incorporated within or installed onto.

## **LICENSE**

Subject to the terms and conditions of this Agreement, Tektronix grants You a non-exclusive, non-transferable license to the Software, as follows

**You may:**

1. Use the Software with the Equipment, or if the Software is not encoded or incorporated in any Tektronix equipment, on no more than one machine at a time; and
2. Copy the Software for archival or backup purposes, provided that no more than one (1) such copy is permitted to exist at any one time, and provided that each copy includes a reproduction of any patent or copyright notice or restrictive rights legend that was included with the Software, as received from Tektronix;
3. Fully transfer the Equipment to a third party but only if prominently accompanied by this End User License Agreement, and such third-party recipients agree to be bound by the terms of this Agreement; and
4. Integrate Tektronix products that contain the Software into a system and sell or distribute that system to third parties, provided that those third parties are bound by the terms of this Agreement, and provided that You (i) do not separate the Software from any Equipment it is incorporated into, (ii) do not retain any copies of the Software, and (iii) do not modify the Software.

**You may not:**

1. Use the Software other than for its intended purpose as provided above in the section “You may,” or in conflict with the terms and restrictions of this Agreement;
2. Distribute or transfer the Software to any person or organization outside of Your organization without Tektronix’s prior written consent, except in connection with a permitted use authorized in “You may” paragraphs 3 or 4 above;
3. Decompile, decrypt, disassemble, or otherwise attempt to derive the source code, techniques, processes, algorithms, know-how, or other information (collectively “Reverse Engineer”) from the Software or permit or induce any third party to do so, except to the limited extent allowed by directly applicable law or third party license (if any), and only to obtain information necessary to achieve interoperability of independently created software with the Software;
4. Modify, translate, adapt, or create derivative works of the Software, or merge the Software with any other software;
5. Copy the documentation accompanying the Software;
6. Remove any copyright, trademark, or other proprietary notices from the Software or any media relating thereto; or
7. Export or re-export, directly or indirectly, the Software or Equipment, any associated documentation, or systems created in accordance with “You may” section 4 above, to any country to which such export or re-export is restricted by law or regulation of the United States or any foreign government having jurisdiction without the prior authorization, if required, of the Office of Export Administration, Department of Commerce, Washington, D.C. and the corresponding agency of such foreign government;
8. Use the Software or Equipment in any manner or for any purpose that infringes, misappropriates, or otherwise violates any intellectual property rights or other proprietary rights of any person, or any applicable laws;

9. Use the Software or Equipment in a network or system with other products or services that are incompatible, insecure or not compliant with applicable laws;
10. Bypass, circumvent, damage or otherwise interfere with any security or other features of the Software or Equipment designed to control the manner in which they are used, or harvest or mine Tektronix's proprietary content or information from the Software or Equipment.

THE SOFTWARE MAY NOT BE USED, COPIED, MODIFIED, MERGED, OR TRANSFERRED TO ANOTHER EXCEPT AS EXPRESSLY PERMITTED BY THESE TERMS AND CONDITIONS.

#### **FEEDBACK**

If You provide feedback to Tektronix concerning the functionality and performance of the Software or Equipment, including without limitation identifying potential errors and improvements, any comments, questions, suggestions, or the like ("Feedback"), Tektronix is free to use such Feedback without any attribution, compensation, or restriction in any manner to improve or enhance its products, irrespective of any other obligation or limitation between the Parties governing such Feedback. You hereby grant Tektronix an irrevocable, worldwide, perpetual, royalty-free license to use Your Feedback for any purpose whatsoever and waive any moral rights You may have in the Feedback. Tektronix is not obligated to use Your Feedback.

#### **OWNERSHIP**

Title to the Software and all copies thereof, but not the media on which the Software or copies may reside, shall remain with Tektronix or others from whom Tektronix has obtained a respective licensing right.

#### **GOVERNMENT NOTICE**

If the Software or any related documentation is acquired by or for an agency of the U.S. Government, the Software and documentation shall be considered "commercial computer software" or "commercial computer software documentation" respectively, as those terms are used in 48 CFR §12.212, 48 CFR §227.7202, or 48 CFR §252.227-7014, and are licensed with only those rights as are granted to all other licensees as set forth in this Agreement.

#### **TERM**

The license granted herein is effective until terminated. The license may be terminated by You at any time upon written notice to Tektronix. The license may be terminated by Tektronix if You fail to comply with any term or condition and such failure is not remedied within fifteen (15) days after notice hereof from Tektronix. Upon termination by either party, You shall return to Tektronix or destroy, the Software and all associated documentation, together with all copies in any form.

IF YOU TRANSFER, DISTRIBUTE, OR OTHERWISE MAKE AVAILABLE ANY COPY, MODIFICATION, OR MERGED PORTION OF THE SOFTWARE WITHOUT THE AS EXPRESS PERMISSION OF THESE TERMS AND CONDITIONS OR PRIOR WRITTEN CONSENT OF TEKTRONIX, YOUR LICENSE WILL BE IMMEDIATELY AND AUTOMATICALLY TERMINATED.

#### **LIMITED WARRANTY**

Tektronix does not warrant that the functions contained in the Software will meet Your requirements or that the operation of the Software will be uninterrupted, secure, or error-free.

EXCEPT AS SEPARATELY PROVIDED IN A WRITTEN WARRANTY FROM TEKTRONIX, THE SOFTWARE IS PROVIDED "AS IS" WITHOUT ANY WARRANTY OF ANY KIND, EXPRESS OR IMPLIED, INCLUDING BUT NOT LIMITED TO, THE WARRANTIES OF MERCHANTABILITY, FITNESS FOR A PARTICULAR PURPOSE, TITLE, QUIET ENJOYMENT, AND NON-INFRINGEMENT.

THE SOFTWARE IS NOT DESIGNED OR INTENDED FOR USE IN HAZARDOUS ENVIRONMENTS REQUIRING FAIL-SAFE PERFORMANCE INCLUDING WITHOUT LIMITATION, IN THE OPERATION OF NUCLEAR FACILITIES, AIRCRAFT NAVIGATION OR COMMUNICATION SYSTEMS, AIR TRAFFIC CONTROL, WEAPONS SYSTEMS, DIRECT LIFE-SUPPORT MACHINES, OR ANY OTHER APPLICATION IN WHICH THE FAILURE OF THE SOFTWARE COULD LEAD TO DEATH, PERSONAL INJURY OR SEVERE PHYSICAL OR PROPERTY DAMAGE (COLLECTIVELY "HAZARDOUS ACTIVITIES"). TEKTRONIX AND ITS AFFILIATES, LICENSORS, AND RESELLERS EXPRESSLY DISCLAIM ANY EXPRESS OR IMPLIED WARRANTY OF FITNESS FOR HAZARDOUS ACTIVITIES.

#### **LIMITATION OF LIABILITY**

IN NO EVENT SHALL TEKTRONIX, ITS AFFILIATES, LICENSORS, OR RESELLERS BE LIABLE FOR: (1) ECONOMICAL, INCIDENTAL, CONSEQUENTIAL, INDIRECT, SPECIAL, PUNITIVE OR EXEMPLARY DAMAGES, WHETHER CLAIMED UNDER CONTRACT, TORT OR ANY OTHER LEGAL THEORY, (2) LOSS OF OR DAMAGE TO YOUR DATA OR PROGRAMMING, LOSS OF PROFITS, BUSINESS INTERRUPTION, OR OTHER PECUNIARY LOSS ARISING FROM THE USE OF (OR INABILITY TO USE) THE SOFTWARE, (3) PENALTIES OR PENALTY CLAUSES OF ANY DESCRIPTION, (4) ANY DAMAGE, CLAIMS, OR LOSSES RESULTING FROM THE USE OF THE SOFTWARE IN CONJUNCTION WITH OTHER PRODUCTS OR SERVICES (INCLUDING THIRD-PARTY PRODUCTS OR SERVICES); OR (5) INDEMNIFICATION OF YOU OR OTHERS FOR COSTS, DAMAGES, OR EXPENSES RELATED TO THE GOODS OR SERVICES PROVIDED UNDER THIS LIMITED WARRANTY, EVEN IF TEKTRONIX OR ITS AFFILIATES, LICENSORS, OR RESELLERS HAVE ADVANCE NOTICE OF THE POSSIBILITY OF SUCH DAMAGES. BECAUSE SOME STATES/JURISDICTIONS DO NOT ALLOW THE EXCLUSION OR LIMITATION OF LIABILITY FOR CONSEQUENTIAL OR INCIDENTAL DAMAGES, SOME OF THE ABOVE LIMITATIONS MAY NOT APPLY TO YOU, BUT THEY SHALL APPLY TO THE MAXIMUM EXTENT PERMITTED BY LAW. NOTWITHSTANDING ANYTHING HEREIN TO THE CONTRARY, IN NO EVENT SHALL TEKTRONIX'S TOTAL AGGREGATED LIABILITY TO YOU FOR ALL DAMAGES IN ANY ONE OR MORE CAUSES OF ACTION EXCEED THE AMOUNT RECEIVED BY TEKTRONIX FROM YOU FOR THE SOFTWARE OR EQUIPMENT.

You are solely responsible for Your data. You must back up Your data before Tektronix or a third party performs any remedial, upgrade, or other work on Your systems, including any Equipment. If applicable law prohibits exclusion of liability for lost data, then Tektronix will only be liable for the cost of the typical effort to recover the lost data from Your last available back up.

### **SECURITY DISCLAIMER**

This Software and its associated Equipment are not designed or intended to be used with unsecure networks. You acknowledge that use of the Equipment may rely upon certain networks, systems, and data communication mediums that are not controlled by Tektronix and that may be vulnerable to data or security breaches, including, without limitation, internet networks used by Your internet providers and the databases and servers controlled by Your internet providers. Tektronix shall not be liable for any such breaches, including without limitation, damages and/or loss of data related to any security breach, and disclaims all warranties, including any implied or express warranties that any content will be secure or not otherwise lost or altered.

For the avoidance of doubt, if You choose to connect this Software or Equipment to a network, it is Your sole responsibility to provide and continuously ensure a secure connection to that network. You agree to establish and maintain appropriate measures (e.g., firewalls, authentication measures, encryption, anti-virus applications, etc.) to protect the Software and Equipment and any associated data against security breaches including unauthorized access, destruction, use, modification, or disclosure. Notwithstanding the foregoing, You shall not use any Products in a network with other products or services that are incompatible, insecure or not compliant with applicable laws.

### **THIRD-PARTY DISCLAIMER**

The Software may contain software owned by third parties and obtained under a license from those parties (“Third Party Software”). Your use of such Third Party Software is subject to the terms and conditions of this Agreement and the applicable Third Party Software licenses. Except as expressly agreed otherwise, third parties do not warrant the Third Party Software, do not assume any liability with respect to its use, and do not undertake to furnish any support or information relating thereto.

### **GENERAL**

Unless the Customer is the United States Government, this Agreement contains the entire agreement between the parties with respect to the use, reproduction, and transfer of the Software, and shall be governed by the laws of the state of Oregon.

You shall be responsible for any taxes that may now or hereafter be imposed, levied or assessed with respect to the possession or use of the Software or the rights and licenses granted under this Agreement, including any sales, use, property, value added, and excise taxes, and similar taxes, duties, or charges.

Any waiver by either party of any provision of this Agreement shall not constitute or be deemed a subsequent waiver of that or any other portion.

You may not assign this Agreement or any right or obligation under this Agreement, or delegate any performance, without Tektronix’s prior written consent. This section does not prohibit You from transferring the Equipment in accordance with Subsections 3 and 4 of the Section titled “You may” above.

All questions regarding this Agreement should be directed to the nearest Tektronix Sales Office.



---

# Important safety information

This manual contains information and warnings that must be followed by the user for safe operation and to keep the product in a safe condition. To safely perform service on this product, additional information is provided at the end of this section.

## General safety summary

Use the product only as specified. Review the following safety precautions to avoid injury and prevent damage to this product or any products connected to it. Carefully read all instructions. Retain these instructions for future reference.

Comply with local and national safety codes.

For correct and safe operation of the product, it is essential that you follow generally accepted safety procedures in addition to the safety precautions specified in this manual.

The product is designed to be used by trained personnel only.

Only qualified personnel who are aware of the hazards involved should remove the cover for repair, maintenance, or adjustment.

Before use, always check the product with a known source to be sure it is operating correctly.

This product is not intended for detection of hazardous voltages.

Use personal protective equipment to prevent shock and arc blast injury where hazardous live conductors are exposed.

While using this product, you may need to access other parts of a larger system. Read the safety sections of the other component manuals for warnings and cautions related to operating the system.

When incorporating this equipment into a system, the safety of that system is the responsibility of the assembler of the system.

**To avoid fire or personal injury**

**Use proper power cord.** Use only the power cord specified for this product and certified for the country of use.

Do not use the provided power cord for other products.

**Ground the product.** This product is grounded through the grounding conductor of the power cord. To avoid electric shock, the grounding conductor must be connected to earth ground. Before making connections to the input or output terminals of the product, ensure that the product is properly grounded.

Do not disable the power cord grounding connection.

**Power disconnect.** The power cord disconnects the product from the power source. See instructions for the location. Do not position the equipment so that it is difficult to access the power cord; it must remain accessible to the user at all times to allow for quick disconnection if needed.

**Connect and disconnect properly.** Do not connect or disconnect probes or test leads while they are connected to a voltage source.

Use only insulated voltage probes, test leads, and adapters supplied with the product, or indicated by Tektronix to be suitable for the product.

**Observe all terminal ratings.** To avoid fire or shock hazard, observe all ratings and markings on the product. Consult the product manual for further ratings information before making connections to the product. Do not exceed the Measurement Category (CAT) rating and voltage or current rating of the lowest rated individual component of a product, probe, or accessory. Use caution when using 1:1 test leads because the probe tip voltage is directly transmitted to the product.

Do not apply a potential to any terminal, including the common terminal, that exceeds the maximum rating of that terminal.

Do not float the common terminal above the rated voltage for that terminal.

**Do not operate without covers.** Do not operate this product with covers or panels removed, or with the case open. Hazardous voltage exposure is possible.

**Avoid exposed circuitry.** Do not touch exposed connections and components when power is present.

**Do not operate with suspected failures.** If you suspect that there is damage to this product, have it inspected by qualified service personnel.

Disable the product if it is damaged. Do not use the product if it is damaged or operates incorrectly. If in doubt about safety of the product, turn it off and disconnect the power cord. Clearly mark the product to prevent its further operation.

Before use, inspect voltage probes, test leads, and accessories for mechanical damage and replace when damaged. Do not use probes or test leads if they are damaged, if there is exposed metal, or if a wear indicator shows.

Examine the exterior of the product before you use it. Look for cracks or missing pieces.

Use only specified replacement parts.

**Do not operate in wet/damp conditions.**

---

**NOTE.** *Be aware that condensation may occur if a unit is moved from a cold to a warm environment.*

---

**Do not operate in an explosive atmosphere.**

**Keep product surfaces clean and dry.** Remove the input signals before you clean the product.

**Provide proper ventilation.** To ensure proper cooling, keep the sides and rear of the instrument clear of obstructions. Slots and openings are provided for ventilation and should never be covered or otherwise obstructed. Do not push objects into any of the openings.

**Provide a safe working environment.** Always place the product in a location convenient for viewing the display and indicators. Avoid improper or prolonged use of button pads. Be sure your work area meets applicable ergonomic standards.

**Probes and test leads**

Before connecting probes or test leads, connect the power cord from the power connector to a properly grounded power outlet.

Keep fingers behind the finger guards on the probes.

Remove all probes, test leads and accessories that are not in use.

Use only correct Measurement Category (CAT), voltage, temperature, altitude, and amperage rated probes, test leads, and adapters for any measurement.

**Beware of high voltages.** Understand the voltage ratings for the probe you are using and do not exceed those ratings. Two ratings are important to know and understand:

- The maximum measurement voltage from the probe tip to the probe reference lead
- The maximum floating voltage from the probe reference lead to earth ground

These two voltage ratings depend on the probe and your application. Refer to the Specifications section of the manual for more information.



**WARNING.** *To prevent electrical shock, do not exceed the maximum measurement or maximum floating voltage for the oscilloscope input BNC connector, probe tip, or probe reference lead.*

---

**Connect and disconnect properly.** Connect the probe output to the measurement product before connecting the probe to the circuit under test. Connect the probe reference lead to the circuit under test before connecting the probe input. Disconnect the probe input and the probe reference lead from the circuit under test before disconnecting the probe from the measurement product.

**Connect and disconnect properly.** De-energize the circuit under test before connecting or disconnecting the current probe.

Connect the probe reference lead to earth ground only.

Do not connect a current probe to any wire that carries voltages or frequencies above the current probe voltage rating.

**Inspect the probe and accessories.** Before each use, inspect probe and accessories for damage (cuts, tears, or defects in the probe body, accessories, or cable jacket). Do not use if damaged.

### Service safety summary

The Service safety summary section contains additional information required to safely perform service on the product. Only qualified personnel should perform service procedures. Read this *Service safety summary* and the *General safety summary* before performing any service procedures.

**To avoid electric shock.** Do not touch exposed connections.

**Do not service alone.** Do not perform internal service or adjustments of this product unless another person capable of rendering first aid and resuscitation is present.

**Disconnect power.** To avoid electric shock, switch off the product power and disconnect the power cord from the mains power before removing any covers or panels, or opening the case for servicing.

**Use care when servicing with power on.** Dangerous voltages or currents may exist in this product. Disconnect power, remove battery (if applicable), and disconnect test leads before removing protective panels, soldering, or replacing components.

**Verify safety after repair.** Always recheck ground continuity and mains dielectric strength after performing a repair.

**Terms in product manuals**

These terms may appear in the product manuals:



**WARNING.** *Warning statements identify conditions or practices that could result in injury or loss of life.*



**CAUTION.** *Caution statements identify conditions or practices that could result in damage to this product or other property.*

**Symbols and terms on the product**

These terms may appear on the product:

- DANGER indicates an injury hazard immediately accessible as you read the marking.
- WARNING indicates an injury hazard not immediately accessible as you read the marking.
- CAUTION indicates a hazard to property including the product.



When this symbol is marked on the product, be sure to consult the manual to find out the nature of the potential hazards and any actions which have to be taken to avoid them. (This symbol may also be used to refer the user to ratings in the manual.)

The following symbols may appear on the product:



CAUTION Refer to Manual    Protective Ground (Earth) Terminal    Functional Earth Terminal    Standby



# Installation

## Before installation

Unpack the oscilloscope and check that you received all items listed as standard accessories. The following pages list recommended accessories and probes, oscilloscope options, and upgrades. Check the Tektronix Web site ([www.tek.com](http://www.tek.com)) for the most current information.

**Table 1: Standard accessories**

Accessory	Description	Tektronix part number
<i>TBS2000B Series Oscilloscopes compliance and Safety Instructions</i>	Printed safety and installation information.	071-3635-xx
Calibration certificate documenting traceability to national metrology institute(s) and ISO9001 quality system registration.		--
Power cord	North America (Option A0)	161-0348-xx
	Universal Euro (Option A1)	161-0343-xx
	United Kingdom (Option A2)	161-0344-xx
	Australia (Option A3)	161-0346-xx
	Switzerland (Option A5)	161-0347-xx
	Japan (Option A6)	161-0342-xx
	China (Option A10)	161-0341-xx
	India (Option A11)	161-0349-xx
	Brazil (Option A12)	161-0356-xx
No power cord or AC adapter (Option A99)	--	

Accessory	Description	Tektronix part number
Front-panel overlays are provided with the ordered language option.	<b>2 channel</b>	
	French (Option L1)	335413700
	Italian (Option L2)	335413800
	German (Option L3)	335413900
	Spanish (Option L4)	335414000
	Japanese (Option L5)	335414100
	Simplified Chinese (Option L7)	335414300
	Traditional Chinese (Option L8)	335414400
	Korean (Option L9)	335414500
	Russian (Option L10)	335414600
	<b>4 channel</b>	
	French (Option L1)	335414700
	Italian (Option L2)	335414800
	German (Option L3)	335414900
	Spanish (Option L4)	335415000
	Japanese (Option L5)	335415100
	Simplified Chinese (Option L7)	335415300
	Traditional Chinese (Option L8)	335415400
	Korean (Option L9)	335415500
	Russian (Option L10)	335415600

**Table 2: Probes**

Oscilloscope model	No of channels	Bandwidth	Description
TBS2072B	2	70 MHz	Probe assembly (one pair), TPP0100, Domestic
TBS2102B	2	100 MHz	Probe assembly (one pair), TPP0200, Domestic
TBS2202B	2	200 MHz	Probe assembly (one pair), TPP0200, Domestic
TBS2074B	4	70 MHz	Probe assembly (one pair), TPP0100, Domestic
TBS2104B	4	100 MHz	Probe assembly (one pair), TPP0200, Domestic
TBS2204B	4	200 MHz	Probe assembly (one pair), TPP0200, Domestic



**Table 3: Optional accessories**

Accessory	Description	Tektronix part number
TEKUSBWIFI	The USB module adds Wi-Fi connectivity for wireless remote programmability and control	TEKUSBWIFI
TekVPI <sup>®</sup> probes that work with TBS2000B Series oscilloscopes	Visit the <i>Oscilloscope Probe and Accessory Selector Tool</i> on the Tektronix Web site at <a href="http://www.tek.com">www.tek.com</a>	
50 Ω BNC adapter	Connect 50 Ω cables to the oscilloscope	013-0227-00
Power measurement deskew and calibration fixture	Converts TEK-DPG pulse generator output into a series of test point connections	067-1686-00
TEK-USB-488 Adapter	GPIB to USB Adapter	TEK-USB-488
Soft transit case	Two-channel oscilloscopes	ACD2000
	Four-channel oscilloscopes	ACD4000B
Hard transit case (requires use of soft transit case)	Two- and four-channel oscilloscopes	HCTEK4321

The TBS2000B series oscilloscopes work with multiple optional probes. See [Connecting probes to the oscilloscope](#) on page 22. Check the Tektronix Web site ([www.tek.com](http://www.tek.com)) for the most current information.

**Table 4: Related documentation**

Accessory	Description	Tektronix part number
<i>TBS2000B Series Oscilloscopes User Manual</i>	English	077-1525-xx
	French	077-1526-xx
	German	077-1527-xx
	Italian	077-1529-xx
	Spanish	077-1530-xx
	Korean	077-1532-xx
	Japanese	077-1533-xx
	Simple Chinese	077-1534-xx
	Traditional Chinese	077-1535-xx
	Russian	077-1536-xx
<i>TBS2000B Series Oscilloscopes Specifications and Performance Verification Manual</i>	Describes the oscilloscope specifications and performance verification procedure. Download from <a href="http://www.tek.com/downloads">www.tek.com/downloads</a> . English only.	077-1538-xx
<i>TBS2000B Series Oscilloscopes Programmer Manual</i>	Describes commands for remote control of the oscilloscope. Download from <a href="http://www.tek.com/manuals">www.tek.com/manuals</a> . English only.	077-1537-xx
<i>TBS2000B Series Oscilloscopes Service Manual</i>	Service information. Download from <a href="http://www.tek.com/downloads">www.tek.com/downloads</a> . English only	077-1539-xx
<i>TBS2000B Series Upgrade Instructions</i>	Upgrade information. Download from <a href="http://www.tek.com/downloads">www.tek.com/downloads</a> . English only	075-1107-xx



# Upgrade license

## To install option upgrade licenses

### TBS2000B Series Oscilloscope option license installation instructions

This document describes how to install option license upgrades on your TBS2000B Series oscilloscope (TBS2072B, TBS2074B, TBS2102B, TBS2104B, TBS2202B, TBS2204B).

Option license upgrades are field-installable licenses that add features to your oscilloscope. Customers can install these option upgrades by installing license files on the oscilloscope. Each option requires a separate license file.

### To install option upgrade licenses

You need the license file from the Tektronix License Management System (LMS) that is provided with each purchased option upgrade.

A single license is valid only for the specific model number and serial number of the instrument for which it was purchased; it will not work on any other instrument. The single license file does not affect options that were factory installed or any other upgrades that you may have already purchased and installed.

1. Follow the instructions you received to download the upgrade license file (<filename>.lic).
2. Copy the license file to a USB memory device.
3. Insert the USB drive into the powered-on oscilloscope for which the upgrade was purchased.
4. Push the **Function** button and push the relevant side-menu button to select the **License** option on the screen.



5. Push the relevant side-menu button to select the **Install License** to open the Browser License Files dialog box.



6. Rotate the Knob to navigate to the file path and press the knob to select the upgrade license file to install.



7. The oscilloscope installs the license and returns to the Install license screen. Power cycle the oscilloscope to enable the installed upgrade(s).



8. Verify that the installed license was added to the Installed Options list.



9. Repeat steps 5 through 8 for each upgrade license file that you purchased and downloaded.

For more information on upgrade options, see the Tektronix Web site (<https://www.tek.com/oscilloscope/tbs2000b-basic-oscilloscope>).



---

# Preface

This manual describes the installation and operation of the following oscilloscopes:

TBS2072B	TBS2074B	TBS2102B	TBS2104B	TBS2202B	TBS2204B
----------	----------	----------	----------	----------	----------

## Key features

This oscilloscope can help you verify, debug, and characterize electronic designs. Key features include:

- Bandwidth variants 70 MHz, 100 MHz and 200 MHz. Ability to upgrade to higher bandwidth for 70 MHz and 100 MHz units post purchase.
- 2 channel and 4 channel models
- TekVPI<sup>®</sup> Versatile Probe Interface supports active voltage and current probes for automatic scaling and units
- Large 9 inch (228 mm) WVGA wide-screen color display
- Sample Rates of 1 GS/s on all Channels (2 GS/s on half Channels)
- Up to 5 million points record length on every channel
- Up to 10,000 waveforms/second capture rate
- Supports 32 automated measurements
- **Edge, Runt and Pulse Width** triggers
- Automated **Search** and **Mark** offers the ability to quickly search for all events of interest within the acquisition.
- **FFT** analysis for waveform spectrum analysis
- Wi-Fi (with optional TEKUSBWIFI dongle) and Ethernet for remote operation and programming
- e\*scope<sup>®</sup> website, accessed by typing instrument IP address into a Web browser, provides remote UI control and SCPI command support
- USB 2.0 Host ports for quick and easy storage of screen images, instrument settings, and waveforms to USB flash drives; installing firmware updates; and loading waveforms and settings from saved files
- USB 2.0 Device port for direct PC control of the oscilloscope using TekVISA connectivity, and other remote connectivity tools that support USBTMC
- **Scope Intro** provides a built-in overview of oscilloscope concepts and an introduction to the TBS2000B controls and features
- **Help Everywhere** displays graphics and short text descriptions when you access the menus for most oscilloscope settings
- **Courseware** function provides on-oscilloscope teaching instruction, with hundreds of courses available on the Tektronix Education Web page and the ability to easily create courses specific to your education needs

## Bandwidth options for TBS2000B

These bandwidth options for TBS2000B Oscilloscope enable you to upgrade the bandwidth of a purchased oscilloscope to a higher bandwidth.

Licence	Description
BWU2-70T100	BW upgrade from 70 MHz to 100 MHz
BWU2-70T200	BW upgrade from 70 MHz to 200 MHz
BWU2-100T200	BW upgrade from 100 MHz to 200 MHz

## Conventions used in this manual

The following icons are used throughout this manual.

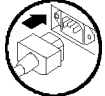
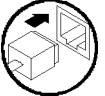
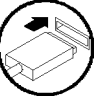
Sequence Step	Front panel power	Connect power	Network	USB
1				



---

# Operating requirements

Make sure to operate the instrument within the following environmental and power requirements.

## Environment requirements

Characteristic	Description
Operating temperature	0 °C to +50 °C, with 5 °C/minute maximum gradient, noncondensing, up to 3000 meter altitude
Operating humidity	5% to 95% relative humidity (% RH) up to +30 °C 5% to 60% RH above +30 °C up to +50 °C, noncondensing
Operating altitude	Up to 3000 meters (9842 feet)

## Power requirements

Characteristic	Description
Power source voltage	Full Range: 100 to 240 VAC RMS $\pm$ 10%, Installation Category II (covers range of 90 to 264 VAC) Sine wave crest factor must be between 1.30 and 1.41.
Power source frequency	47 to 63 Hz over entire source voltage range. 360 to 440 Hz, 100 to 132 VAC RMS Source Voltage.
Power consumption	All models: 80 W maximum



---

**CAUTION.** *A ground connection through the power cord grounding conductor is essential for safe operation.*

---



# Getting acquainted with the oscilloscope

This section shows you how to power on the oscilloscope, and uses a hands-on approach to introduce you to key oscilloscope functions, using the menu system, and verifying that the oscilloscope is operating correctly.

## Powering the oscilloscope

Grounding the oscilloscope is necessary for safety and to take accurate measurements. The oscilloscope must share the same ground as any circuits that you are testing. You connect the oscilloscope to ground by plugging the three-pronged power cord into an outlet grounded to earth ground.

To power the oscilloscope on:

1. Connect the power cord supplied with the instrument to the oscilloscope power connector.
2. Connect the power cord to the appropriate AC main source.
3. Push the front panel **Power** button.

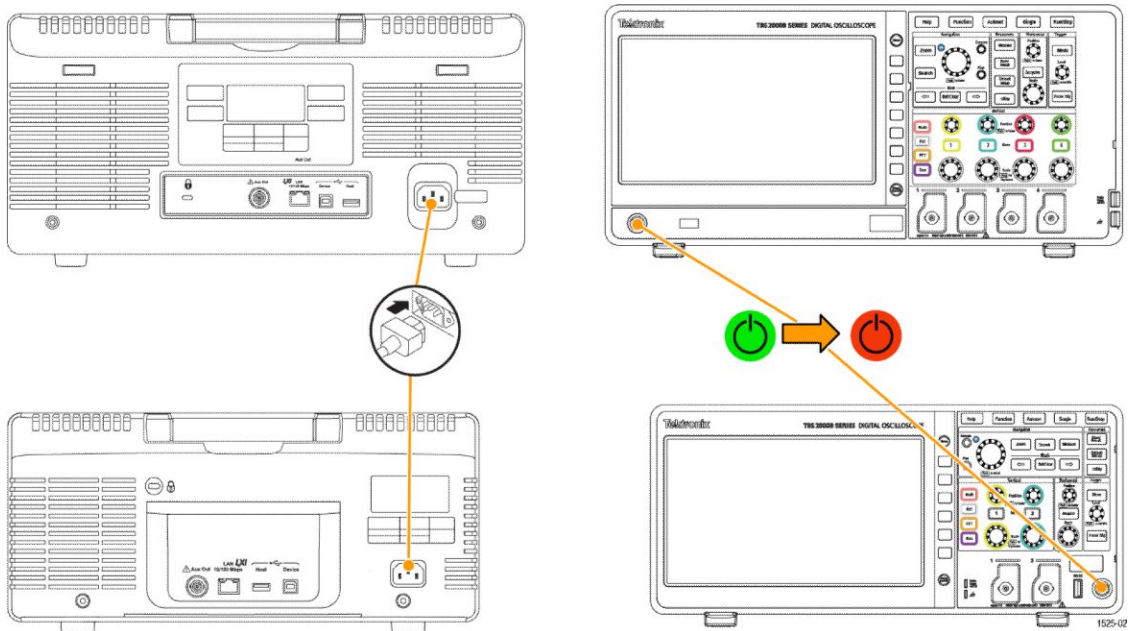

To power off the oscilloscope on: cord:

1. Push the front panel **Power** button.
2. Disconnect the power cord from the main source and the oscilloscope power connector.

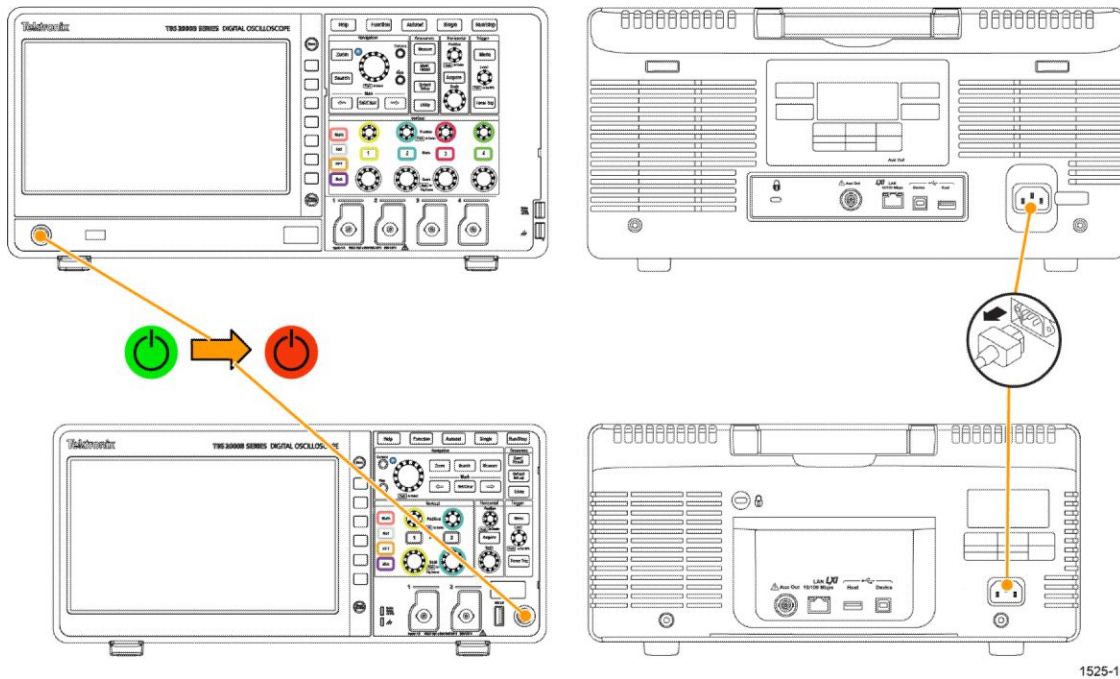

---

**NOTE.** The current instrument settings are stored in nonvolatile memory when you power off the oscilloscope. The oscilloscope restores the settings when you power on.

---

## Changing the user interface language

You can change the language used for the oscilloscope on-screen display, measurements, readouts, and menus to one of 11 languages.

The following steps show how to change the user interface language. These steps also introduce you to the oscilloscope menu system.

1. Push the **Utility** front-panel button. The oscilloscope displays a side menu on the right side of the screen.

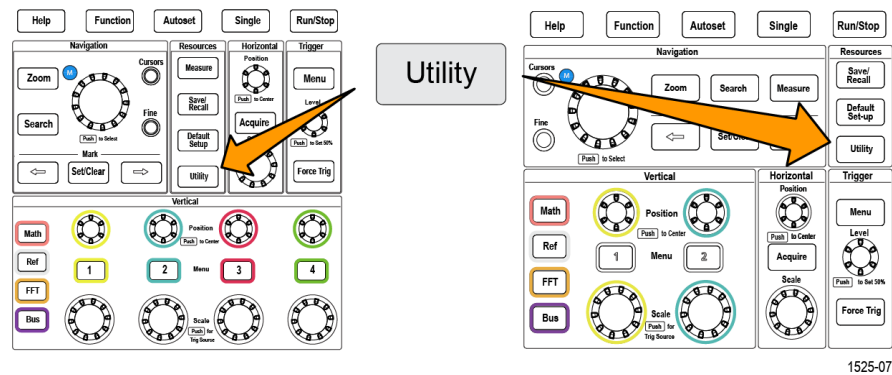

2. Push the **Language** side-menu button.



The oscilloscope opens the **Language** menu.

You will use the **Multipurpose** knob to select and click menu items. The following text describes how the **Multipurpose** knob works.

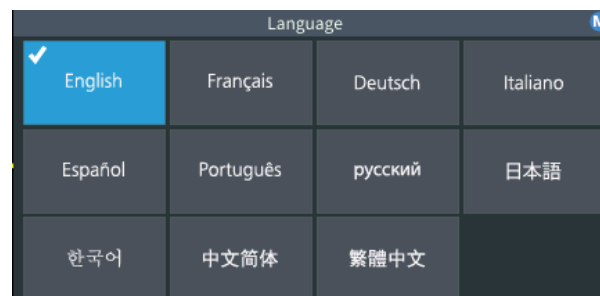

The **Multipurpose** knob lets you interact with on-screen menus, messages, and dialog boxes.

A **M** icon on a menu, message, or dialog box label means that you can use the Multipurpose knob to select and click values in that item.

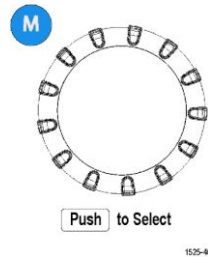

The turn arrow indicator, located below the knob, turns green when you can use the knob to make selections or enter values in a menu or dialog box.

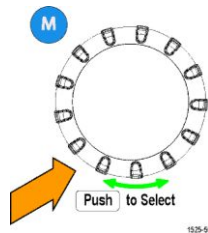

The knob has two functions:

- **Select** function, where you *turn* the knob to select (highlight) a menu item. Selecting a menu item does not execute (run) that function.

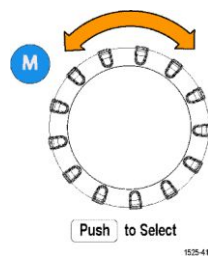

- **Click** function, where you *push* the knob to either run the selected menu item or enable a field in that menu item to enter numbers or select values.

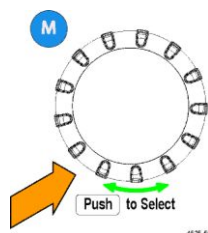

3. Turn the **Multipurpose** knob to select a language.



4. Push the **Multipurpose** knob to select the highlighted language. The selected language takes effect immediately.

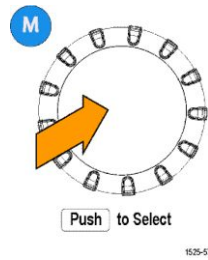

5. Push the **Menu On/Off** button to close the **Utility** menu.

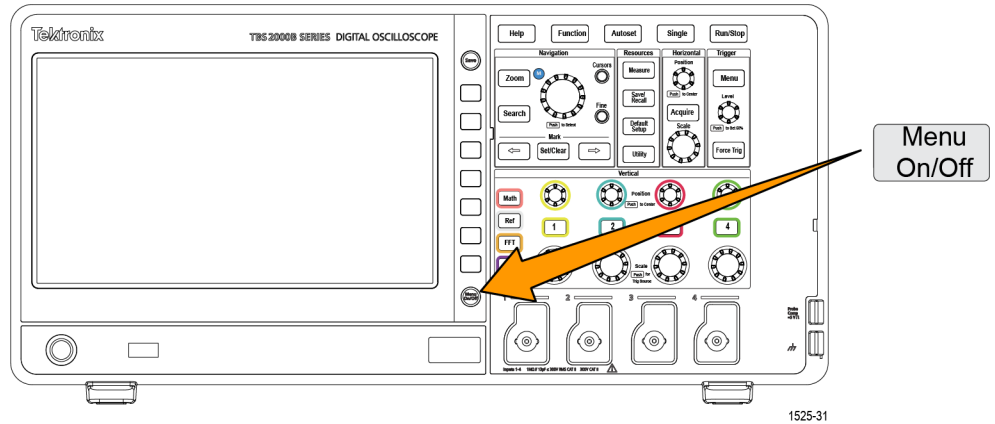

6. If you load a language other than English, install the plastic overlay on the front panel to provide labels in that language. Fold the overlay tabs. Push the overlay over the knobs until the knob hole tabs click over the bottom edges of the knobs. Insert the overlay tabs into the small slots.

If you are changing from a non English language to English, remove the front-panel language overlay.

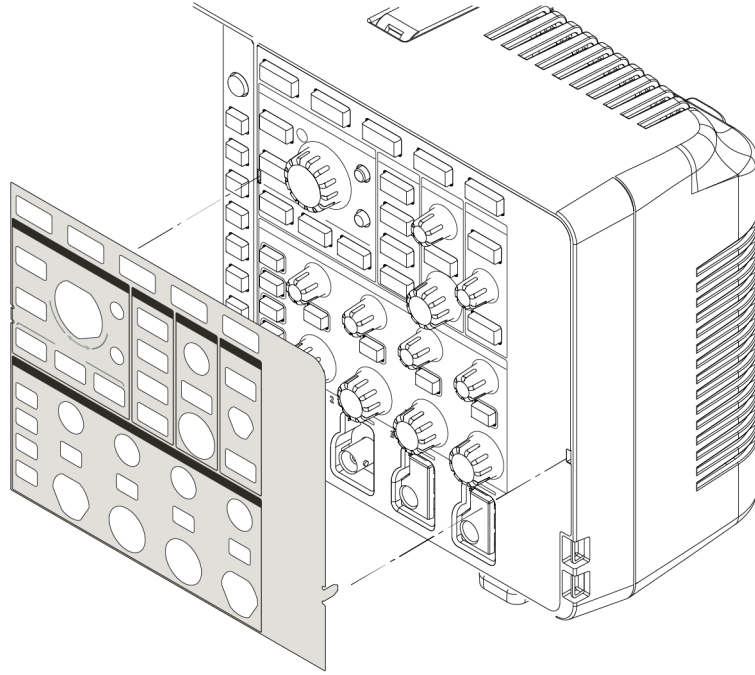

1525-17



## Changing the date and time

Set the current date and time so that files that you save are marked with the correct date and time. The date and time are shown in the lower-right corner of the screen. Time is shown using a 24-hour clock.

**NOTE.** The clock does not automatically adjust for seasonal time changes. The calendar does adjust for leap years.

The following steps show how to set the oscilloscope clock with the current date and time. These steps also introduce you to more functions of the menu system.

1. Push **Utility** front-panel button.

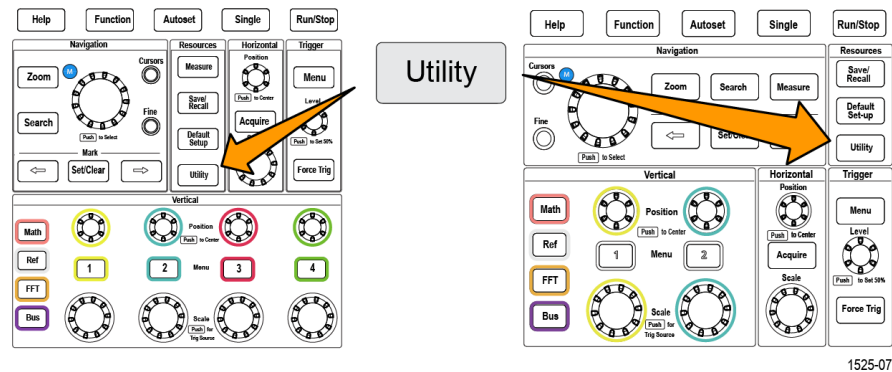

2. Push **Set Date & Time** side-menu button. The oscilloscope shows the **Set Date & Time** menu.

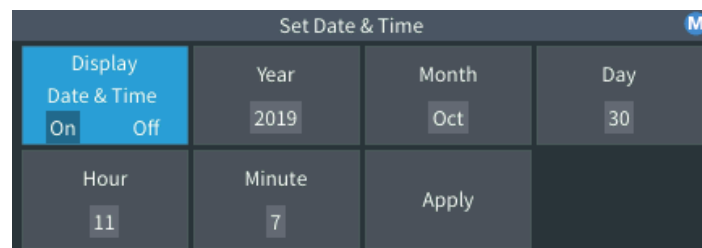

3. Turn the **Multipurpose** knob to select the **Year** field.

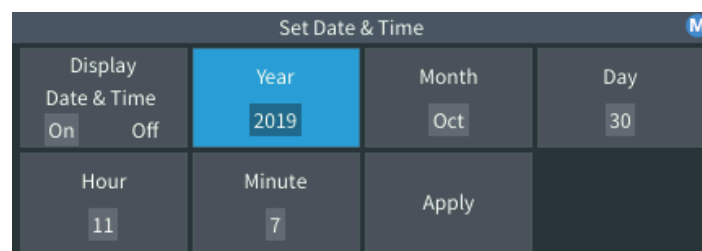

- Click the **Multipurpose** knob to enable setting the year value. A white box is drawn around the number field, indicating that you can use the **Multipurpose** knob to change that value.

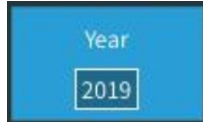

- Turn the **Multipurpose** knob to change the year value in the field.  
When the value is correct, click the **Multipurpose** knob. This enters the number and returns the knob to menu select mode.



- Repeat steps 2 - 5. to select and change the remaining date and time settings (**Month, Day, Hour, Minute**).

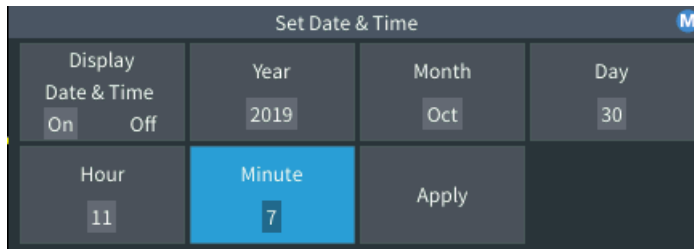

- When you have finished making all date and time changes, turn the **Multipurpose** knob to select **Apply**, then click the knob to enter the date/time settings into the oscilloscope.

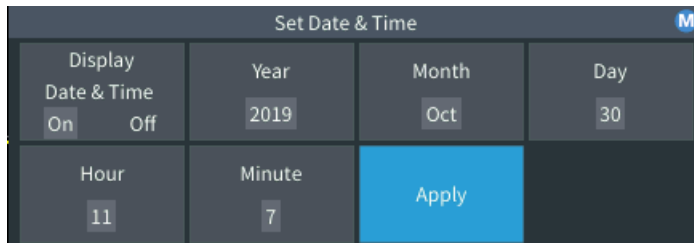

- To turn off displaying the date and time, select **Display Date & Time** and click the **Multipurpose** knob to toggle **On** or **Off**.

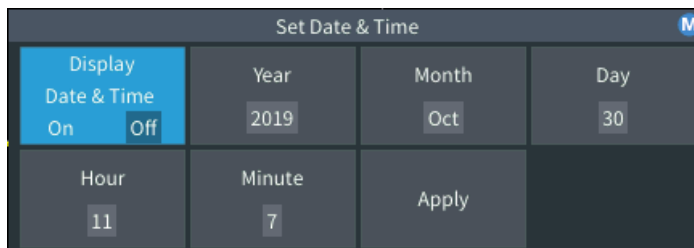

9. Push the **Menu On/Off** button to close the **Utility** side menu.

The new date and time are shown in the lower-right corner of the screen.

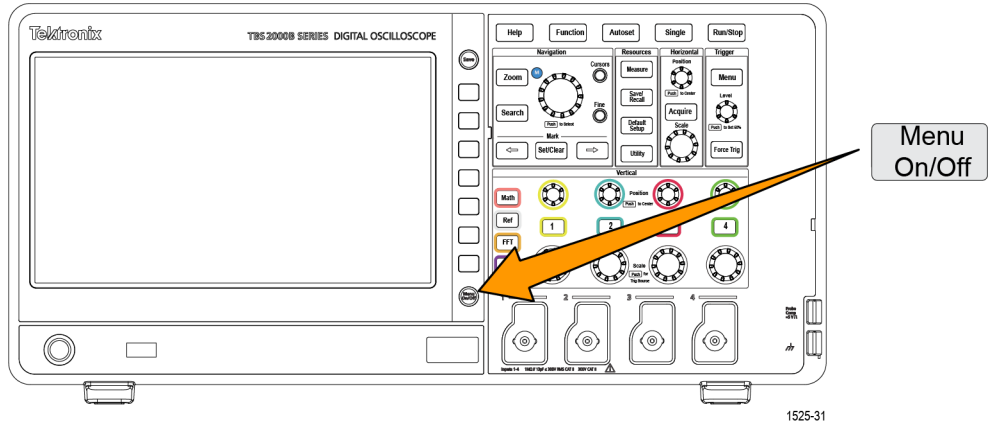

## Connecting probes to the oscilloscope

You must connect probes or cables to an oscilloscope before you can display a waveform and take measurements. The following text describes how to connect probes to the oscilloscope.

1. BNC probes or cables: Push the BNC probe or cable on to the connector so that the connector pins align with the slots, then turn the BNC connector clockwise to lock. The probes that ship with the oscilloscope are BNC connector probes.

---

**NOTE.** *If you connect a cable to the channel input, you will need an impedance matching adapter to convert the cable impedance (typically 50  $\Omega$ , but it depends on the cable) to work with the 1 M $\Omega$  channel input impedance.*

---

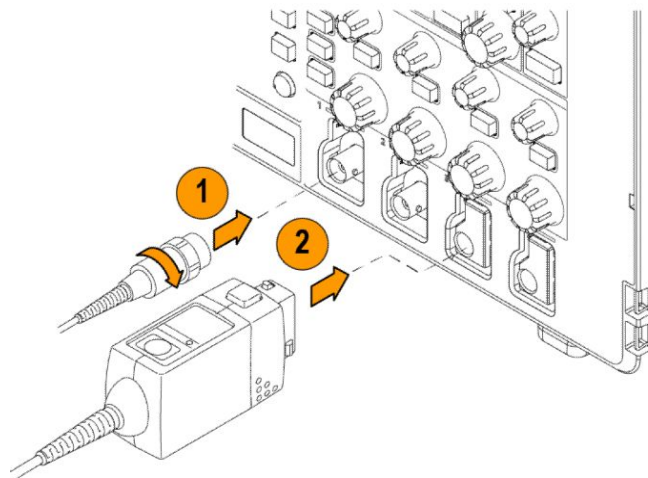

1525-05

2. Tektronix Versatile Probe Interface (TekVPI<sup>®</sup>): Push the probe base into the channel connector until the probe base connector clicks. To remove, push and hold the button on the probe base and pull the probe from the connector.

TekVPI<sup>®</sup> probes automatically set the oscilloscope probe parameters such as type (voltage, current) and attenuation (10X, 1X, X10, and so on).

## Supported probe types

For more information on the many probes available for use with TBS2000B Series oscilloscopes, visit the Oscilloscope Probe and Accessory Selector tool on the Tektronix Web site ([www.tek.com](http://www.tek.com)).

## Reducing electrostatic damage while taking measurements

Static electricity that builds up on your body can damage static-sensitive components. If you are working with static-sensitive components, ground yourself when using probes. Wearing a grounding strap safely sends static charges on your body to earth ground.

Connect the grounding strap to the oscilloscope ground, or to the same ground circuit that the oscilloscope is connected to.

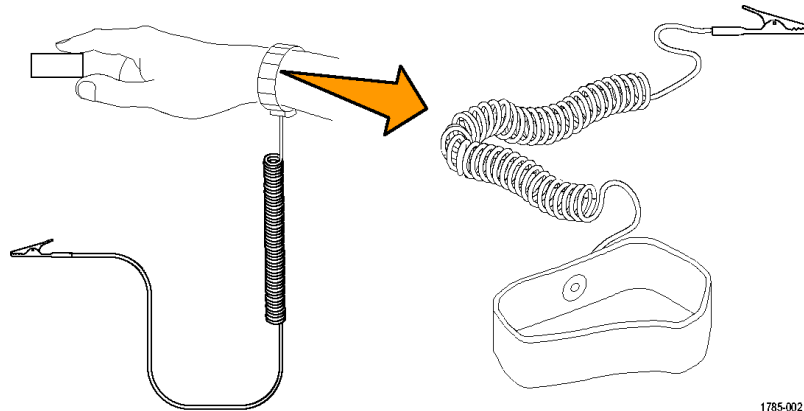

1785-002

## Doing a functional check

Perform this quick functional check to verify that your oscilloscope is operating correctly.

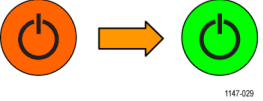
Connect the oscilloscope power cable as described in <i>Powering On the Oscilloscope</i> . See <a href="#">Powering the oscilloscope</a> on page 13.	
Power on the oscilloscope.	 <p>1147-029</p>

Connect a probe to channel 1.

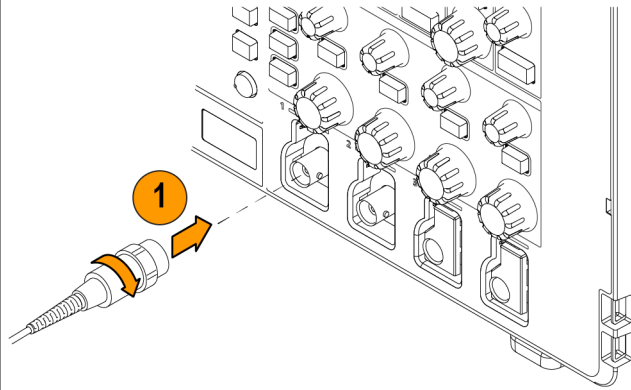

1525-34

Connect the probe tip and ground lead to the **PROBE COMP** connectors on the oscilloscope front panel. The probe tip connects to the 5 V connector, and the ground clip connects to the ground connector.

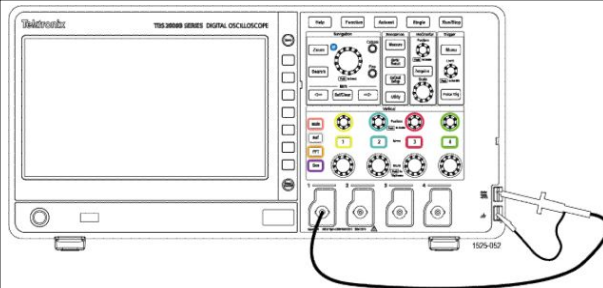

Push **Default Setup**. Default Setup returns the oscilloscope settings to factory default values. See [The default oscilloscope settings Default Setup](#) on page 194.

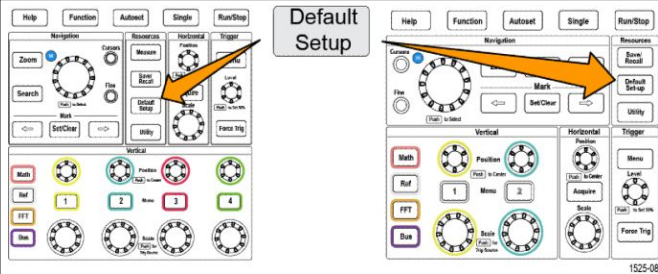

1525-08

Push **Autoset**.

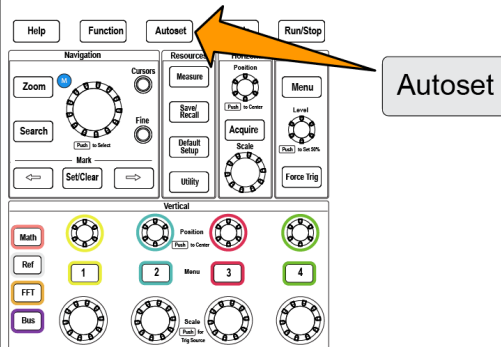

1525-09

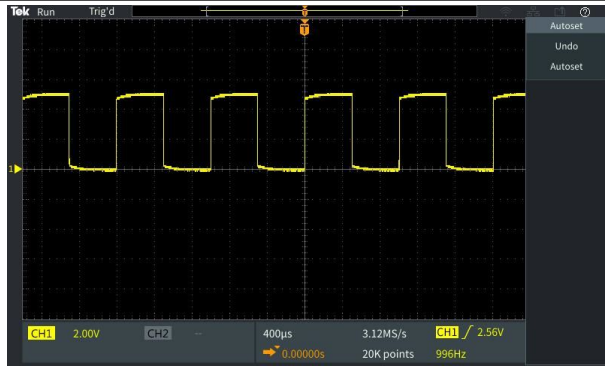
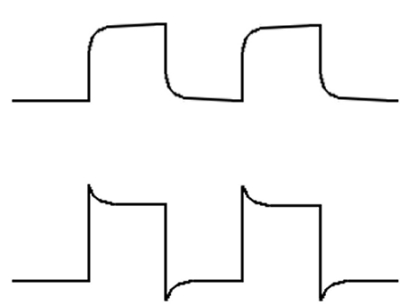
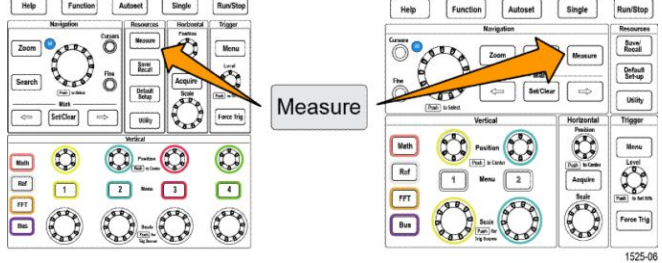
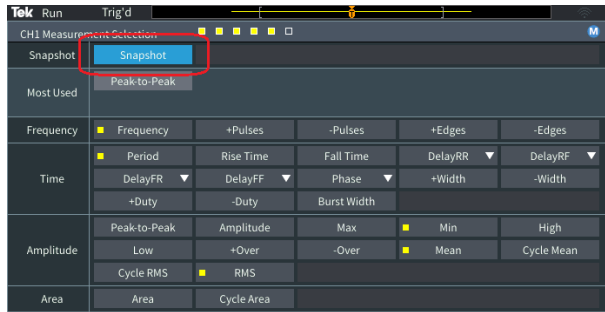
<p>The screen displays a square wave.</p>	
<p>If the displayed square wave tops are not flat, perform the procedures to compensate the probe high frequency response. You can compensate the probe after completing this functional check. See <a href="#">Compensating a passive voltage probe</a> on page 28.</p>	
<p>Push <b>Measure</b> to open the <b>Measurement Selection</b> menu.</p>	
<p>Turn the <b>Multipurpose</b> knob to select <b>Snapshot</b>.</p>	

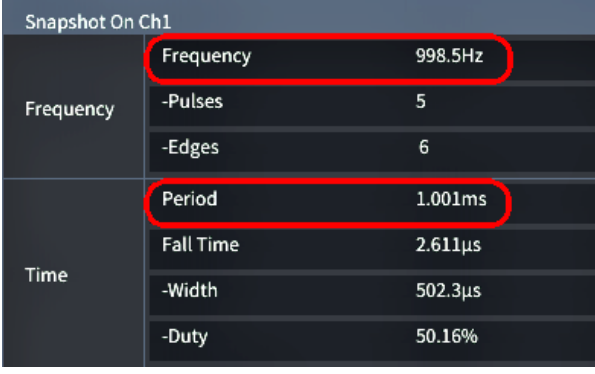
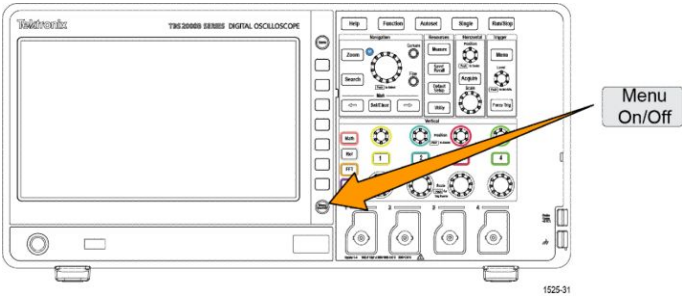

<p>Click the <b>Multipurpose</b> knob to show the <b>Snapshot</b> screen. See <a href="#">Taking a measurement snapshot</a> on page 91.</p> <p>Verify that the <b>Frequency</b> value is ~1 kHz and the <b>Period</b> value is ~1 ms, respectively.</p>	 <table border="1"> <thead> <tr> <th colspan="2">Snapshot On Ch1</th> </tr> </thead> <tbody> <tr> <td rowspan="3">Frequency</td> <td>Frequency</td> <td>998.5Hz</td> </tr> <tr> <td>-Pulses</td> <td>5</td> </tr> <tr> <td>-Edges</td> <td>6</td> </tr> <tr> <td rowspan="4">Time</td> <td>Period</td> <td>1.001ms</td> </tr> <tr> <td>Fall Time</td> <td>2.611μs</td> </tr> <tr> <td>-Width</td> <td>502.3μs</td> </tr> <tr> <td>-Duty</td> <td>50.16%</td> </tr> </tbody> </table>	Snapshot On Ch1		Frequency	Frequency	998.5Hz	-Pulses	5	-Edges	6	Time	Period	1.001ms	Fall Time	2.611μs	-Width	502.3μs	-Duty	50.16%
Snapshot On Ch1																			
Frequency	Frequency	998.5Hz																	
	-Pulses	5																	
	-Edges	6																	
Time	Period	1.001ms																	
	Fall Time	2.611μs																	
	-Width	502.3μs																	
	-Duty	50.16%																	
<p>Push the <b>Menu On/Off</b> button to close the <b>Snapshot</b> screen. Push the <b>Menu On/Off</b> button again to close the <b>Measurement</b> screen.</p>	 <p>The diagram shows the front panel of the oscilloscope with various buttons and knobs. An orange arrow points to a button labeled 'Menu On/Off' on the right side of the control panel.</p>																		

## What is AutosetQuery

The functional check used the **Autoset** button to display a stable waveform. **Autoset** automatically adjusts the oscilloscope acquisition, horizontal, trigger, and vertical controls to display five or six waveform cycles for an active (displayed) channel. This powerful function can save you time when you need to view an unknown signal. See the Autoset topic for more information. See [Using Autoset](#) on page 67.

## Compensating a passive voltage probe

Probe compensation adjusts a passive (nonamplified) voltage probe for the most accurate high-frequency response. The oscilloscope has a 1 kHz square wave source for compensating the probe. Because a square wave contains a significant number of harmonics (multiples of the fundamental frequency), it is an ideal signal source for adjusting the high frequency response of a probe.

A rounded leading edge on the square wave means that the high frequency response of the probe is too low. A spike on the leading edge means that the high frequency response is too high and must be reduced. A square leading edge means that the frequency response is correct for the probe.

Whenever you attach a passive voltage probe for the first time to any input channel, or change a passive probe from one channel to another, you must compensate the probe to match it to that input channel.

To properly compensate your passive probe:

1. Power on the oscilloscope.

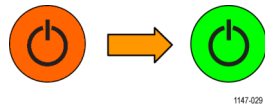

2. Connect the probe to an oscilloscope channel.

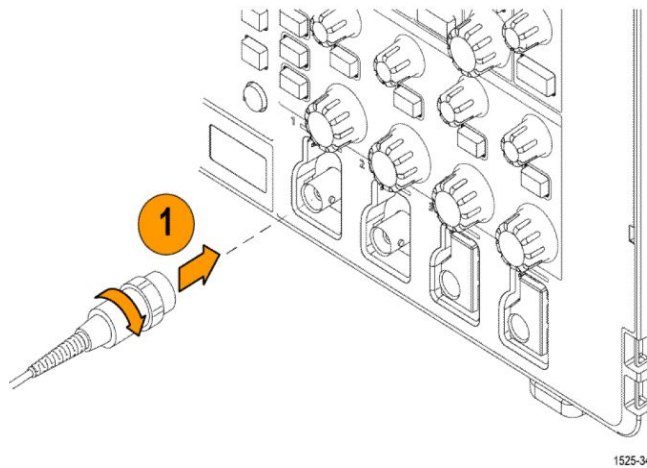

3. Connect the probe tip and ground lead to the **PROBE COMP** connectors on the oscilloscope. The probe tip connects to the 5 V connector, and the ground clip connects to the ground connector.

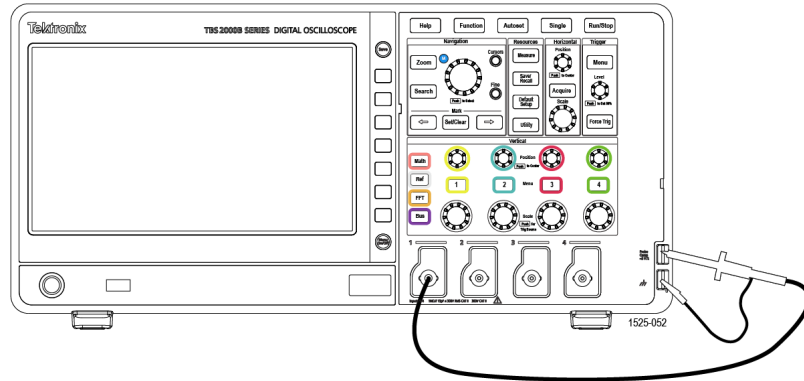

4. Push **Default Setup**.

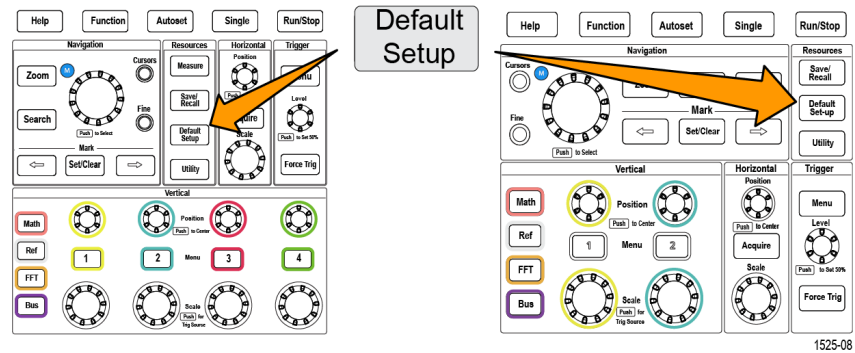

5. Push the **Vertical Menu** button for the channel to which the probe is connected, to display that channel.

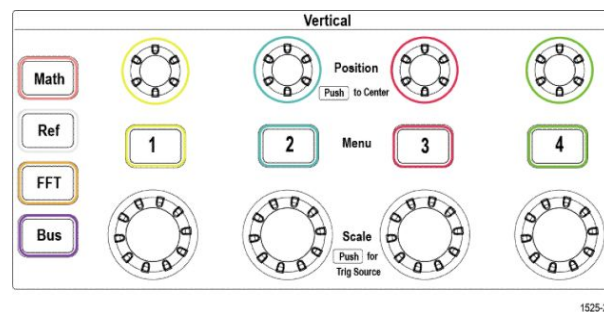

### 6. Push Autoset.

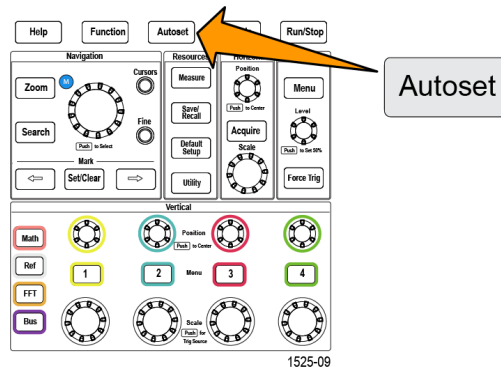

The screen displays a square wave.

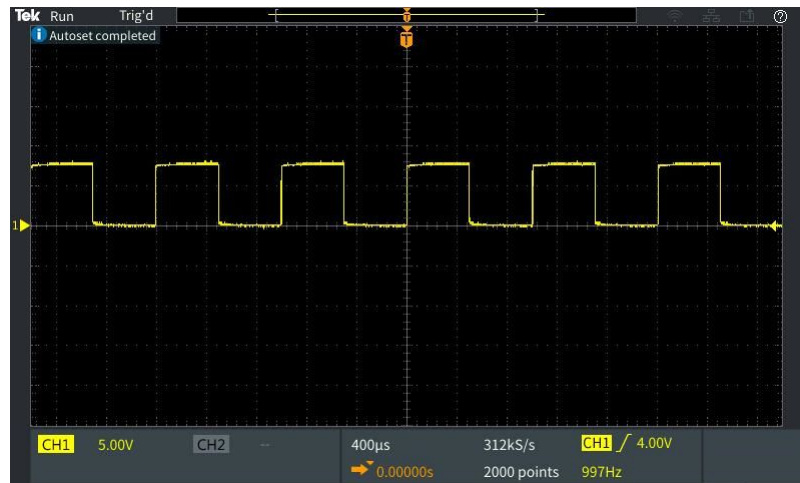

7. Check the shape of the displayed waveform to determine if the probe needs adjusted. If the waveform has a square leading edge and a flat top and bottom, the probe does not need adjusted.



If the waveform leading edge is rounded or has a spike, you need to adjust the probe compensation.

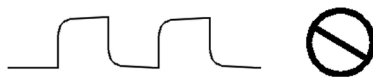

8. Use the probe adjustment tool to adjust the probe to show a flat top and bottom to the waveform. Remove the adjustment tool before looking at the waveform. Repeat until waveform top and bottom are flat.
9. Repeat this procedure from step 2 - 8. for each probe connected to each channel. You must also run this procedure if you move a probe from one channel to another.

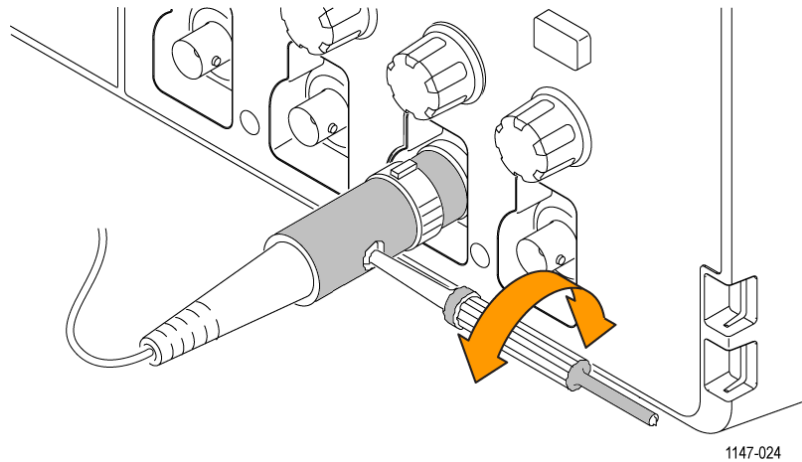

## Probes and ground leads tip

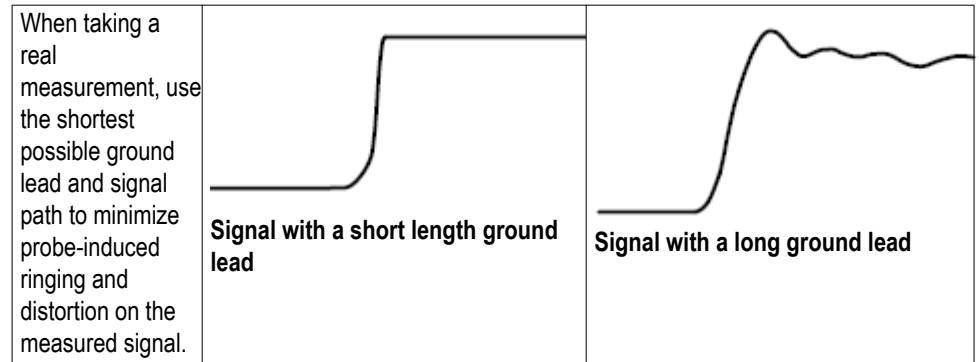

## Signal path compensation SPC

Signal Path Compensation (SPC) corrects for DC level inaccuracies in the internal signal path caused by temperature variations and/or long-term signal path drift. You should run the SPC whenever the ambient (room) temperature has changed by more than 10 °C, or once a week if you use vertical scale settings of 5 mV per division or less. Failure to run a SPC may result in the oscilloscope not meeting warranted performance levels at those volts per division settings.

To compensate the signal path for all channels:

1. Power on and warm up the oscilloscope for at least 20 minutes.
2. **IMPORTANT:** Remove all input signals (probes and cables) from channel inputs and the **Aux Out** connector on the back of the oscilloscope.

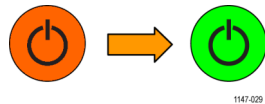

3. Push **Utility**.

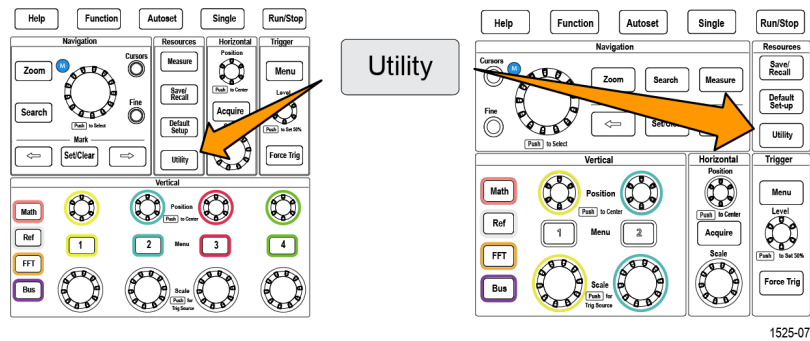

4. Push the **-More- Page 1/2** side-menu button.
5. Push the **Calibration** side-menu button.
6. Turn the **Multipurpose** knob to select **Signal Path**, then click the **Multipurpose** knob to start the SPC process.

The oscilloscope shows a Signal Path Compensation information message.

7. Push the **Compensate Signal Paths** side-menu button to start the process.

The screen shows rotating dots while the SPC is run. The oscilloscope displays a message when the SPC is complete. SPC can take several minutes to run, so wait until the oscilloscope shows a message that SPC is completed.

8. Push **Menu Off** to remove the message and menus.
9. Reconnect probes to the oscilloscope.

## Getting on-screen help for settings - Help Everywhere

**Help Everywhere** is a mode that displays graphics and short text descriptions when you access the menus for most oscilloscope settings. This is very useful for when you are first learning the functions of oscilloscope controls.

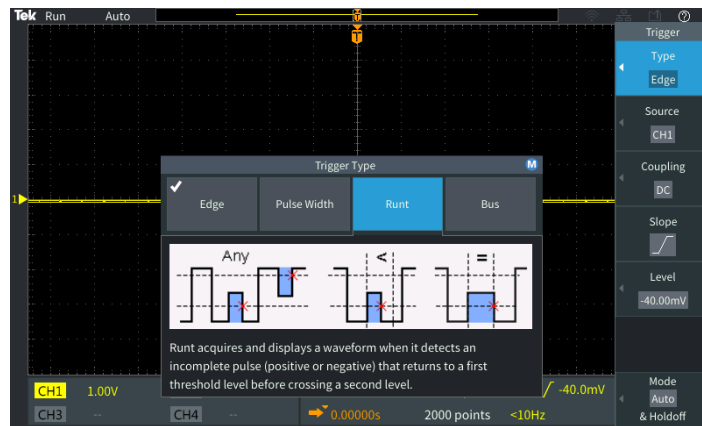

You can enable **Help Everywhere** content for all supported settings, or enable it for specific function groups, such as **Trigger** controls, **Vertical** controls, and so on.

1. Push the **Help** front-panel button.
2. Push the **Help Everywhere** side-menu button to display the menu. All **Help Everywhere** content is set to **Off** by default except for the **Measurement** category, which is **On**.

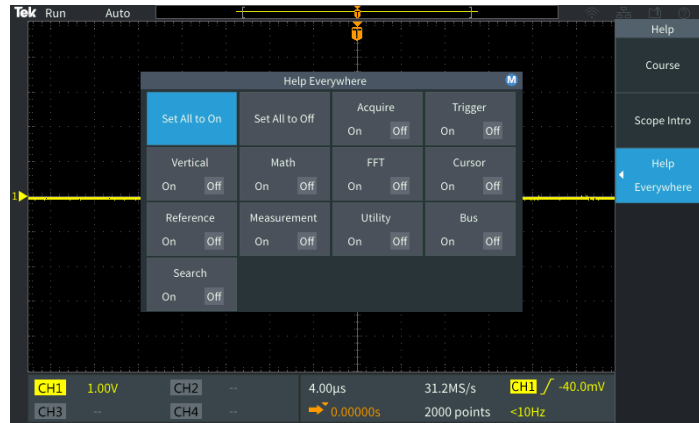

3. To turn all **Help Everywhere** content on or off, use the **Multipurpose** knob to select **Set All to On** or **Set All to Off**, then click the knob.

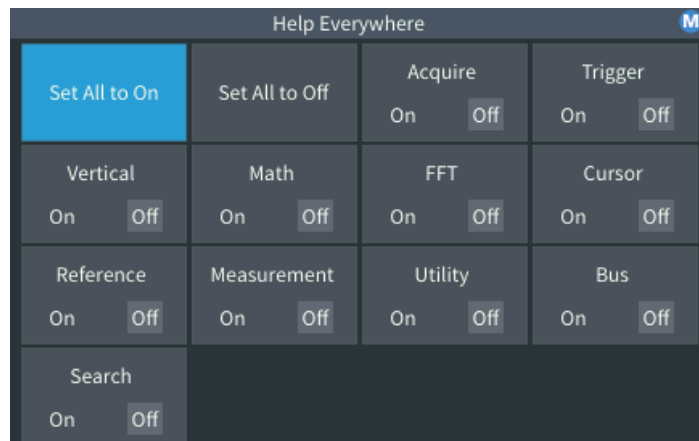



- To set individual menu categories to show **Help Everywhere**, use the **Multipurpose** knob to select a category, then click the knob to toggle that selection **On** or **Off**.

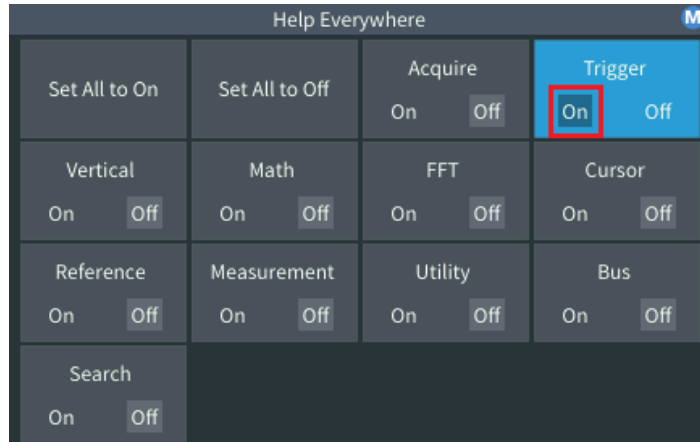

The next time you access a **Help Everywhere** supported menu setting, the oscilloscope displays the help for that item.

**NOTE.** You may need to turn the **Multipurpose** knob and select another menu item to show the **Help Everywhere** content.

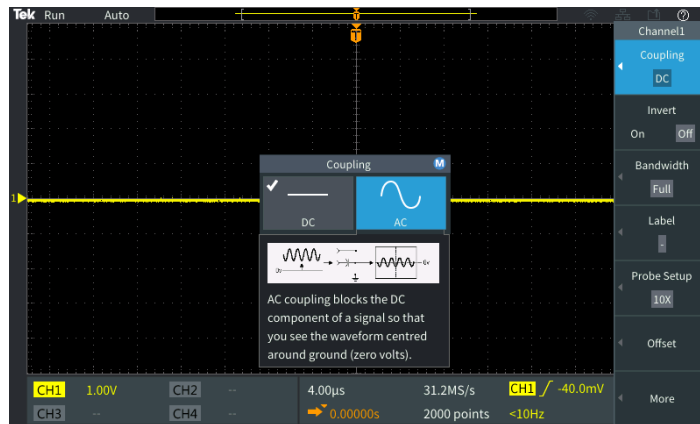

When any **Help Everywhere** content is enabled, the **Help Everywhere** icon is highlighted (in upper right corner of screen).



## The Scope Intro function

The **Scope Intro** function provides a brief history of oscilloscopes, some basic oscilloscope concepts, and an overview of the oscilloscope features and controls.

You can view any topic in any order.

1. Push the **Help** front-panel button.
2. Push the **Scope Intro** side-menu button.
3. Use the **Multipurpose** knob to select and click a topic heading.
4. Use the **Multipurpose** knob to select and click a topic to read.
5. Push the relevant side-menu button to return to the menu for the subject category, and select and click the next topic to view.
6. When you are done viewing the topics for that category, push the **Scope Intro** side-menu button to return to the main menu, and select a new category to read.
7. Push the **Menu On/Off** button to close the **Scope Intro** mode.

---

**NOTE.** *The **Scope Intro** function does not remember which topics you have read.*

---

# Oscilloscope concepts

Read this section if you are a new oscilloscope user, or new to using a digital oscilloscope.

## Sampling and acquisition concepts

Before the oscilloscope can display or measure a signal, it must be sampled. **Sampling** is the process of measuring the input signal amplitude value at regular intervals (called the sampling rate, in samples per second), converting the sampled levels into digital data, and storing the sampled values in memory to create a **waveform record**. The oscilloscope uses the digitized values in the waveform record to create, display, and measure waveforms. Each oscilloscope channel has its own waveform record memory storage.

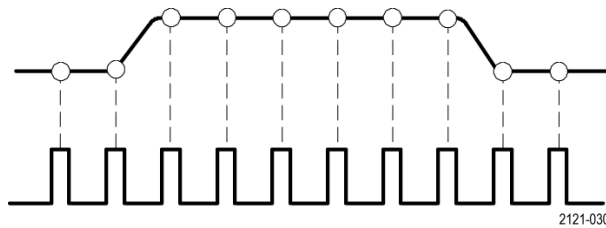

TBS2000B Series oscilloscopes use real-time sampling. In real-time sampling, the oscilloscope samples and digitizes all of the sampled points at one time, in sequence, stores the sampled data in memory, and then repeats the sampling and storage process.

Use the **Horizontal Scale** knob to change the sample rate (samples per second). The oscilloscope automatically sets the sample rate so that there are more than enough samples to accurately capture the signal information. The sample rate is shown on the screen at all times in the horizontal position/scale readout.

---

### NOTE.

- *The maximum sample rate of 2 GS/s is only available when one channel per channel pair is active (channel 1, 2 pair or channel 3, 4 pair).*
  - *For two-channel models, only one channel (either channel 1 or 2) can sample at 2 GS/s. If channel 1 and 2 are both active, then the maximum sample rate changes to 1 GS/s.*
  - *On four-channel models, only two channels can sample at 2 GS/s (one channel from each pair). If channel 1 or 2, and channel 3 or 4, are active, the maximum sample rate is available. Turning on a 2nd channel (in either pair) changes the maximum sampling rate to 1 GS/s.*
-

You can set the waveform **record length** (number of sample points in the waveform record) from 1000 points to 5 million points. A longer (larger) waveform record is useful to capture several waveform cycles to search for a waveform of interest, or to capture a great deal of detail for just a few waveform cycles and then use the **Zoom** function to search the waveform for areas of interest.

Each time the oscilloscope fills the waveform record is called a **waveform acquisition**, or **acquisition** for short. Each acquisition stores new sample data into the same waveform record for that channel.

A waveform record is further divided into **acquisition intervals**, which are equally sized groups of samples. Acquisition intervals let the oscilloscope perform calculations to analyze and display data such as the minimum and maximum data values per interval, or the average signal value per interval. How the values in the acquisition interval are used is set by the acquisition mode.

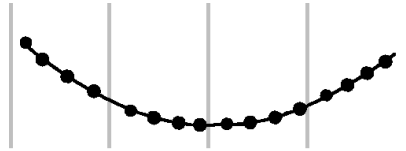

## Acquisition mode concepts

The **acquisition mode** sets how the oscilloscope uses the sampled data points in each acquisition interval to create and display a waveform. You can set the acquisition mode to one of the following modes.

**Sample** mode retains and uses the first sampled point from each acquisition interval to create the displayed waveform. This is the default mode.

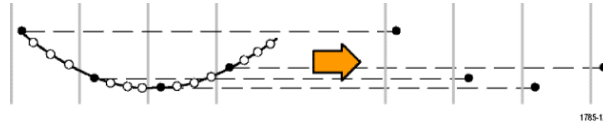

**Peak Detect** mode uses the highest and lowest of all the samples contained in two consecutive acquisition intervals. Use this mode to help detect short rapid transitions in a waveform. Peak Detect is not available at faster time per division settings.

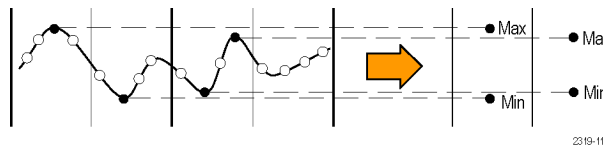

**Hi Res** mode oversamples lower-frequency signals and calculates the average of all the samples for each acquisition interval. Use Hi Res mode to provide higher-resolution (16-bit) sample points for lower-frequency waveforms.

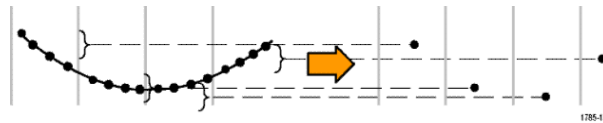

**Average** mode calculates and displays the average value for each sample point over a user-specified number of acquisitions. Use Average mode to reduce random noise.



## Trigger concepts

The oscilloscope uses the data in the waveform record to construct and display a waveform on the oscilloscope screen. However, as the oscilloscope is constantly acquiring samples into the waveform record, each waveform record starts at a random point of the input signal. This means that the waveform record sample values are constantly changing, which results in a displayed waveform that is unstable or jittering. An unstable waveform cannot be accurately measured, making this display useless except for very broad measurements (type of signal, approximate peak to peak signal amplitude).

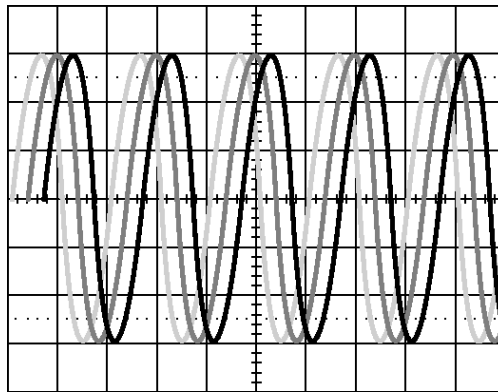

1785-087a

**Figure 1: Untriggered display**

What is needed is a way to set the oscilloscope to detect, or trigger on, the same signal condition or state on the input signal for each waveform acquisition, and store the samples in the waveform record such that the same signal condition is at the same sample time location in the waveform record.

A **trigger** sets when the oscilloscope detects a defined waveform condition, such as at a specified signal voltage level on the rising edge of the signal. The oscilloscope uses that trigger condition to store the waveform samples in the waveform record so that the signal sample point that meets the trigger condition is at the same location in the waveform record. When displayed, the waveform record for each acquisition shows the waveform at the same trigger point, resulting in a stable waveform on the screen.

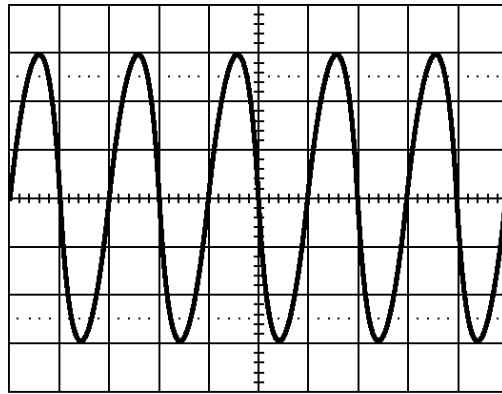

1785-087b

**Figure 2: Triggered display**

Understanding and using triggers is probably the most important skill needed to quickly display and analyze waveforms. A trigger condition can be as simple as when the signal passes through a specified voltage level when going from a low level to a high level (positive slope). A trigger condition can also be very specific, such as when the signal level is falling and the width of a single pulse of the signal is less than a specified time period.

The trigger point in a waveform record also sets the zero time-reference point in a waveform record. By default, the trigger point in a waveform record is in the center of the waveform record. This means that half of the record shows the signal waveform before the trigger condition (pretrigger), and the other half shows the waveform after the trigger condition (post-trigger).

Pretrigger data can help you troubleshoot signal problems. For example, to find the cause of an unwanted glitch in your test circuit, trigger on the glitch signal and look at the pretrigger waveform. By analyzing what happens before the glitch, you may uncover information that helps you find the source of the glitch.

## Trigger slope and level concepts

The oscilloscope must detect both the slope and level conditions before it can trigger and display a stable waveform.

The minimum trigger conditions needed to display a stable waveform are the signal slope and threshold level. The slope sets the oscilloscope to find the trigger point on the rising or the falling edge of a signal. The level sets where on that edge the trigger point occurs.

The trigger **Slope** sets the oscilloscope to find the trigger event on the rising or the falling edge of a signal.

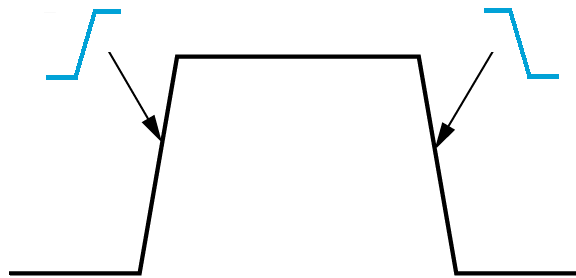

The trigger threshold **Level** (or just level) is the signal amplitude value on a slope that must occur for the oscilloscope to trigger on a signal.

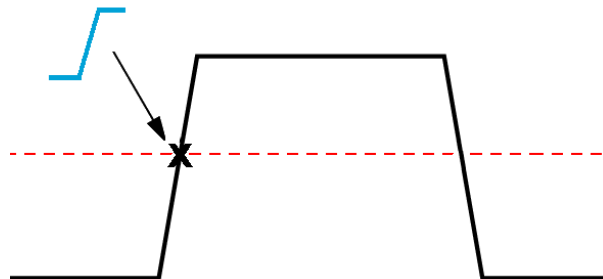



A runt trigger needs two thresholds to define the two levels that a signal must pass through to be considered a valid (nonrunt) signal.

The arrow at the far right of the screen marks the threshold level(s) for that signal.

Turning the **Trigger Level** knob changes the threshold level and momentarily displays a long horizontal line (or two lines for a runt trigger) across the waveform to show the trigger level(s) in relation to the overall waveform.

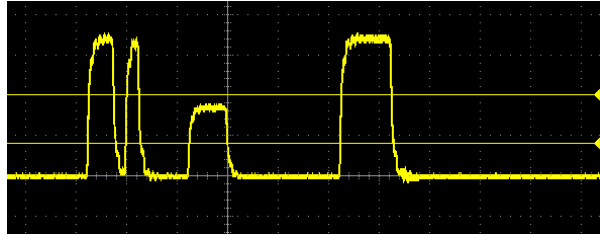

## Available trigger types

The oscilloscope lets you trigger on several signal conditions:

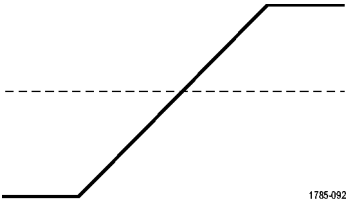
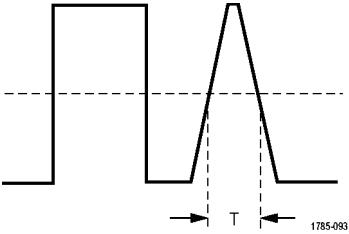
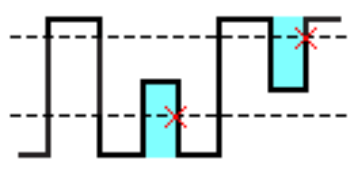
Trigger type		Trigger conditions
Edge	 <p>1785-092</p>	<p>Edge triggers are the simplest and most commonly used trigger type. An edge trigger event occurs when the trigger source passes through a specified voltage threshold (trigger level) when the signal is transitioning in the specified slope (rising or falling). You can trigger on a rising or falling edge, as defined by the slope control.</p>
Pulse Width	 <p>1785-093</p>	<p>You can trigger on pulses that are less than, greater than, equal to, or not equal to a specified time period. You can trigger on positive or negative pulses. Pulse width triggers are primarily used to analyze digital signals.</p>
Runt		<p>A runt pulse is a pulse that crosses one threshold but fails to cross a second threshold before recrossing the first. Therefore, a runt trigger needs two thresholds to define the two levels that a signal must pass through to be considered a valid (nonrunt) signal. You can trigger on any positive or negative (or either) runt signal. You can also trigger on runt signals with pulse widths that are less than, greater than, equal to, or not equal to a specified width. Runt triggers are primarily used to analyze digital signals.</p>

## Trigger coupling

Trigger coupling sets what part of the input signal is used by the trigger circuit. Trigger coupling choices are **DC**, **LF Reject**, **HF Reject**, and **Noise Reject**.

- **DC Coupling** passes the trigger signal to the trigger circuit with no filtering. The scope may trigger on false events if the signal is noisy.
- **HF Reject** attenuates signals above 85 kHz from the trigger circuit. This reduces false triggering on high-frequency noise when measuring lower-frequency signals.
- **LF Reject** attenuates signals below 65 kHz from the trigger circuit. This reduces false triggering from low frequency noise when measuring higher-frequency signals.
- **Noise Reject** reduces the trigger circuit input sensitivity. This reduces false triggering when measuring signals with higher levels of noise.

## Trigger modes

The Trigger **Mode** sets how the oscilloscope behaves in the absence or presence of a trigger. Trigger mode also enables the trigger holdoff function.

## Auto Untriggered Roll trigger mode

The **Auto (Untriggered Roll)** mode sets the oscilloscope to acquire a waveform even if a trigger does not occur. Auto mode uses a timer that starts when the acquisition is started, and the pretrigger information is obtained. If a trigger event is not detected before the timer times out, the oscilloscope forces a trigger. The length of time it waits for a trigger event depends on the time base setting (**Horizontal Scale**).

Auto mode, when forcing triggers in the absence of valid triggering events, does not synchronize the waveform on the display. The waveform will appear to roll across the screen. If valid triggers occur, the display will become stable.

## Normal trigger mode

**Normal** mode sets the oscilloscope to acquire a waveform only when a trigger condition occurs. If no trigger occurs, the last waveform record acquired remains on the display. If no last waveform exists, no waveform is displayed.

## Holdoff trigger mode

The **Holdoff** trigger mode lets you set a time period during which the oscilloscope ignores trigger events. For example, to trigger on the first pulse of a pulse burst, you would set the trigger conditions to trigger on a positive edge, and set the holdoff value so that the trigger is disabled for a period of time after the trigger event but before the next occurs. Using Holdoff in this case prevents the oscilloscope from triggering on any positive signal edge.

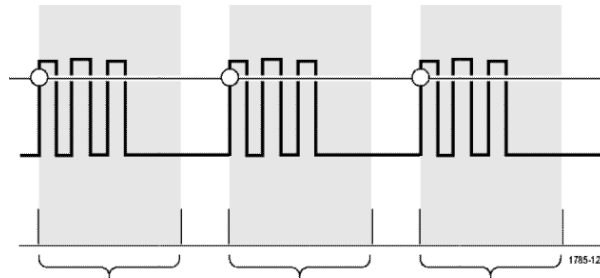

Use **Set Holdoff to minimum** to set the holdoff value to the minimum value.

---

**NOTE.** The trigger mode does not set the trigger conditions; those are set with the trigger **Type** controls. See [Available trigger types](#) on page 44.

---

## Trigger delay acquisition mode

In normal acquisition modes, the trigger point is located at the center of the waveform record, and is positioned at the center-screen expansion point so that horizontal scale changes are centered around the trigger point. The **Delay** function in the **Acquire** menu disconnects the trigger point from the center-screen expansion point. This feature lets you use the **Horizontal Position** knob to reposition (delay) the trigger point from the expansion point by a specified amount.

The most common use for **Delay** is to acquire and display waveform detail that is separated after the trigger event by a significant interval of time. For example, you can trigger on a pulse that occurs once every 10 ms and then use **Delay** to look at the signal characteristics that occur 6 ms after the trigger point.

# Setting channel input parameters

Use the vertical **Menu** buttons to select waveforms to display or open menus and submenus with which to set input parameters for each channel.

Each channel's settings are independent of every other channel.

## Setting input signal coupling

Input signal coupling sets how the input signal is passed to the oscilloscope sampling circuit.

1. Push the **Vertical Menu** button for the channel input that you want to set.

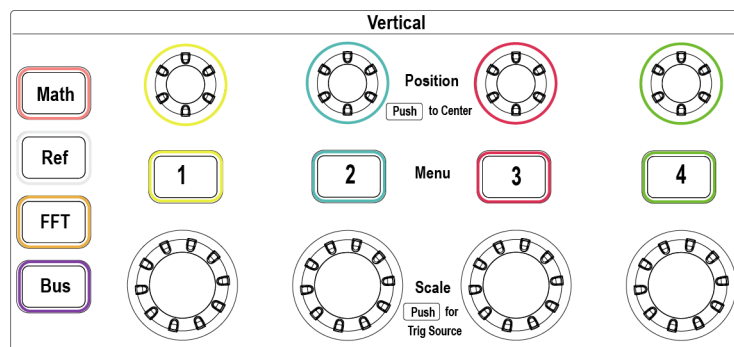

1525-27

2. Push the **Coupling** side-menu button.
3. Use the **Multipurpose** knob to select and click the coupling type:  
**DC** coupling passes both AC and DC signal components.  
**AC** coupling blocks the DC component and passes only the AC signal.

## Inverting the input signal

Use this procedure to invert (flip vertically) the signal. A typical reason to invert a signal is to use the inverted signal to create a math waveform.

1. Push the **Vertical Menu** button for the channel input that you want to set.

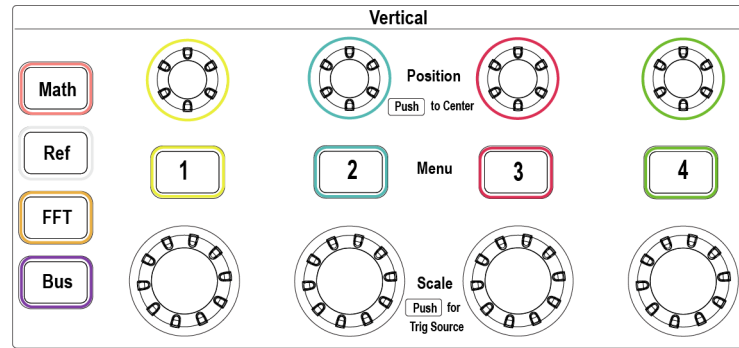

1525-27

2. Push the **Invert** side-menu button to toggle between **Off** for normal operation and **On** to invert the polarity of the signal in the preamplifier.

## Setting the oscilloscope bandwidth

Use this procedure to set the oscilloscope bandwidth. Bandwidth is the maximum frequency that an oscilloscope can accurately display and measure. The oscilloscope gradually attenuates (reduces) the signal level of frequencies that are higher than the bandwidth. This means that although you can display signals that are above the bandwidth limit, their amplitude values and other characteristics are not guaranteed to be accurate.

1. Push the **Vertical Menu** button for the channel input that you want to set.

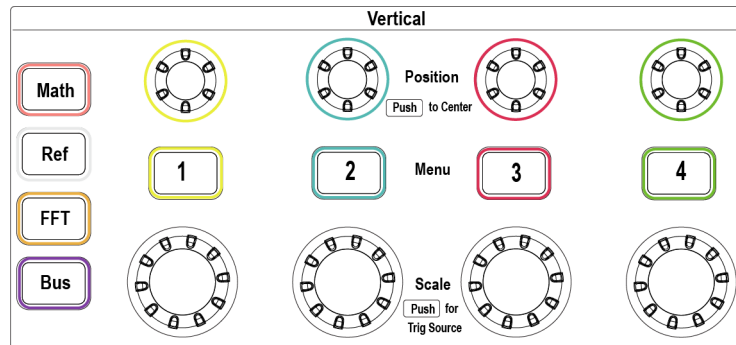

1525-27

2. Push the **Bandwidth** side-menu button.
3. Use the **Multipurpose** knob to select and click the bandwidth setting.
  - **Full** sets the bandwidth to the maximum bandwidth of which the oscilloscope is capable.
  - **20 MHz** sets the bandwidth to 20 MHz.
  - Other bandwidth choices may be shown on the menu depending on the connected probe.

## Setting the probe type voltage or current

The **Probe Type** submenu sets the type for probe that is connected to the oscilloscope. The default probe type is **Voltage**. The other valid probe type is current. Probes that have a TekProbe II or TekVPI interface automatically set the probe type and related parameters when you plug them into the oscilloscope.

1. Push the **Vertical Menu** button for the channel input that you want to set.

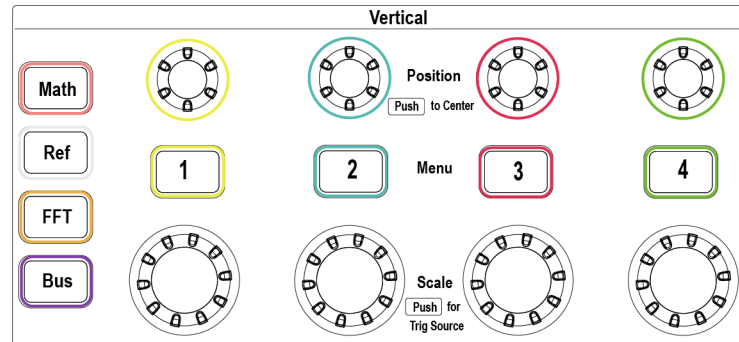

1525-27

2. Push the **Probe Setup** side menu to display the **Probe Setup** submenu.
3. Use the **Multipurpose** knob to select and click **Probe Type** submenu item.
4. Select and click the probe type (**Voltage** or **Current**).



## Setting the probe attenuation factor

Attenuation is the amount that the probe reduces or amplifies the input signal amplitude before sending it to the oscilloscope input. The **Attenuation** submenu sets the probe attenuation factor for probes that do not have the TekProbe II or TekVPI interface. The default attenuation is **10x**.

1. Push the **Vertical Menu** button for the channel input that you want to set.

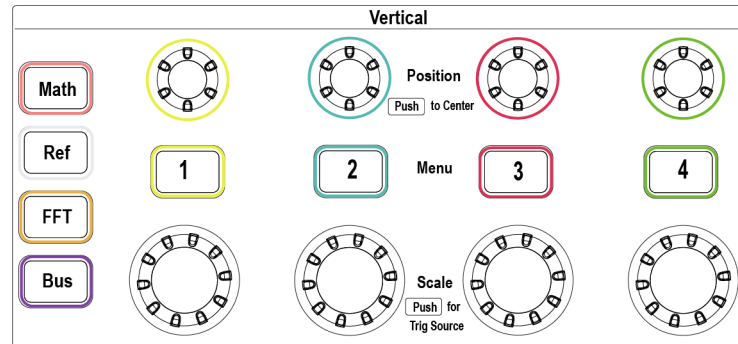

1525-27

2. Push the **Probe Setup** side menu to display the **Probe Setup** submenu.
3. Use the **Multipurpose** knob to select and click the **Attenuation** submenu item.
4. Use the **Multipurpose** knob to select and change the attenuation factor.

## Quickly setting the probe attenuation to 1X or 10X

The **Set To 1X** and **Set To 10X** submenu items let you quickly set the probe attenuation to either 1X or 10X.

1. Push the **Vertical Menu** button for the channel input that you want to set.

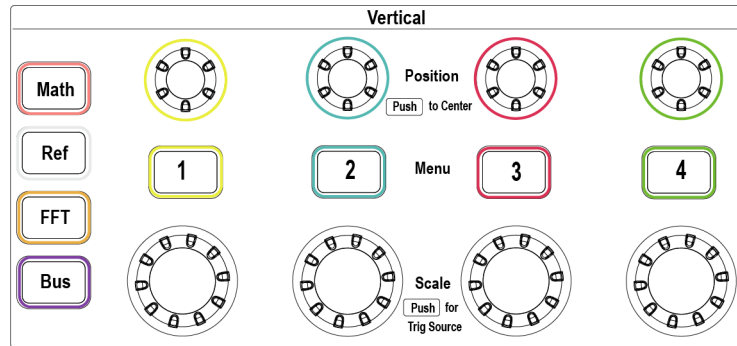

1525-27

2. Push the **Probe Setup** side menu to display the **Probe Setup** submenu.
3. Use the **Multipurpose** knob to highlight either **Set To 1X** or **Set To 10X** submenu item. Then click the **Multipurpose** knob to set that value.

## Setting the measure current mode for voltage probes

If you are measuring current by using a standard voltage probe to measure the voltage drop across a resistor, use the **Measure Current** field to set the Amps/Volts or Volts/Amps ratio of your measurement setup. For example, if you are measuring the voltage drop across a 2  $\Omega$  resistor to determine the current, set the V/A ratio to 2.

1. Push the **Vertical Menu** button for the channel input that you want to set.

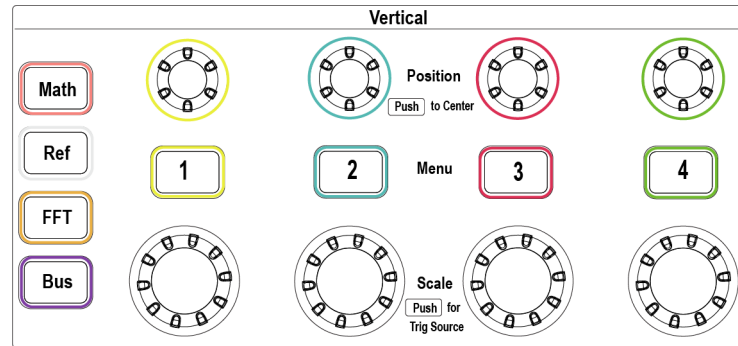

2. Push the **Probe Setup** side menu to display the **Probe Setup** submenu.
3. Use the **Multipurpose** knob to highlight the **Measure Current** submenu item.
4. Push the **Multipurpose** knob to toggle between **Yes** and **No**.
5. If you select **Yes**, the area below the Measure Current submenu displays the Amps/Volts or Volts/Amps ratio menu item. Use the **Multipurpose** knob to select and change the current measurement parameter.

## Setting the input signal vertical offset

The **Offset** menu lets you set the vertical signal offset, which changes the waveform position relative to the oscilloscope ground (0 volts) reference. This menu also lets you quickly set a signal's vertical offset to 0. See [The difference between vertical position and vertical offset](#) on page 56.

1. Push the **Vertical Menu** button for the channel input that you want to set.

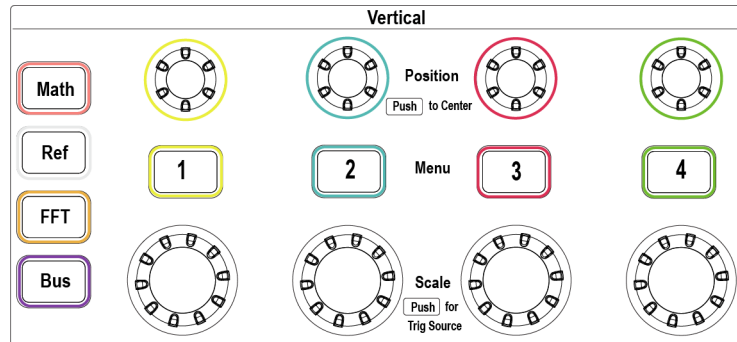

1525-27

2. Push the **Offset** side-menu button.
3. To set a specific offset voltage, use the **Multipurpose** knob to select and click the offset value field. Use the knob to change the value; the waveform on the screen moves as you change the value. Click the knob again to exit the field.
4. To set the offset value to 0, use the **Multipurpose** knob to select and click **Set to 0**.

## Setting the waveform vertical position

To quickly position a waveform position, use the **Vertical Position** knob on the front panel for the channel that you want to move.

The **Position** submenu lets you set the vertical signal position, which moves the waveform up or down on the screen. This menu also lets you quickly set the waveform 0 (ground) value to the center horizontal graticule. See [The difference between vertical position and vertical offset](#) on page 56.

1. Push the **Vertical Menu** button for the channel input that you want to set. Each channel's settings are independent of the other channels.

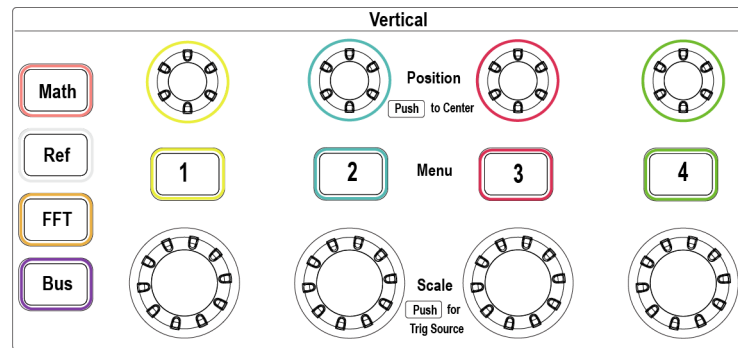

1525-27

2. Push the **More** side-menu button.
3. Use the **Multipurpose** knob to select and click **Position** to show the Position submenu.
4. To set a specific position value, use the **Multipurpose** knob to select and click the position field. Use the knob to change the value; the waveform on the screen moves as you change the value. Click the knob again to exit the field.
5. To set the position to 0 (center graticule), use the **Multipurpose** knob to select and click **Set to 0**.

## The difference between vertical position and vertical offset

- Vertical *position* is a display function that moves the waveform image on the screen. Moving the signal on the screen does not change the ground (0 volt) baseline level for that signal.
- Vertical *offset* is a signal function that adds a DC voltage to the input signal before the oscilloscope preamplifier. Adding this DC voltage moves, or offsets, the signal from the ground (0 volts) level. You use offset to increase the effective dynamic range of a signal.

For example, you can set the vertical offset to match the peak area of a signal, use the **Vertical Position** knob to move the peak area to the center graticule, and then set the **Vertical Scale** knob to smaller voltage/division settings to look at more detail in that waveform peak area.

## Setting channel deskew

**Deskew** compensates for differences in signal delays between different cable lengths or probe types. Use **Deskew** to adjust the signal delay for individual channels so that all signals arrive at the oscilloscope at the same time. Deskewing channels lets you take accurate time-related measurements between two or more channels, or when using a current probe with a voltage probe.

Select one probe as a reference signal and adjust the deskew values for the other channels so that they all align. For best results, use a deskew fixture, such as the Tektronix 067-1686-xx.

The following image shows before and after using deskew to set channel 2 and 4 deskew to minimize the delay with channel 1.

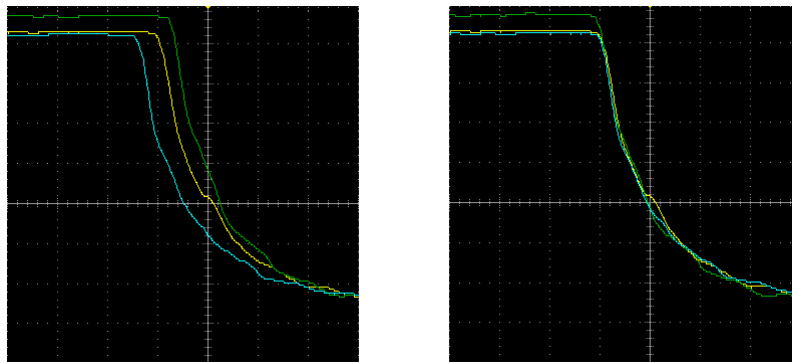

1. Push the **Vertical Menu** button for the channel input that you want to set.

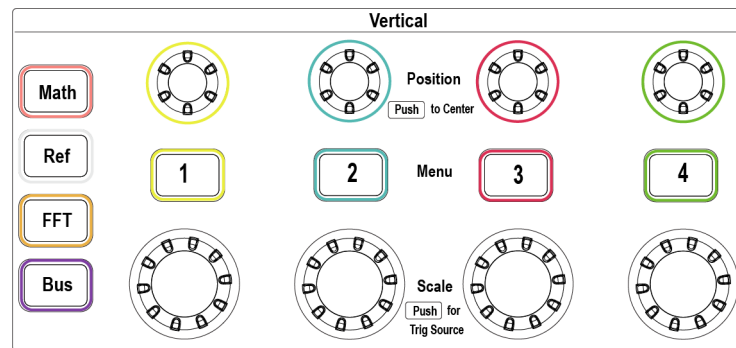

2. Push the **More** side-menu button.
3. Use the **Multipurpose** knob to select and click **Deskew**.
4. To set a specific deskew delay, use the **Multipurpose** knob to select and click **0s**. Then use the knob to change and set the value. The waveform on the screen moves as you adjust the value.

5. To set the deskew to the oscilloscope default (0 delay), use the **Multipurpose** knob to select and click **Set to Default**.

### Deskew tips

- **Deskew** settings are stored in nonvolatile memory until changed manually for each channel.
- **Deskew** settings are included in saved setup files.
- Doing a **Default Setup** resets deskew values to 0 on all channels.



---

# Trigger setup

Use these procedures to set up the oscilloscope to trigger on a signal. See [Trigger concepts](#) on page 40.

## Triggering on a waveform edge

Use this procedure to set the oscilloscope to trigger on the rising or falling edge of a waveform.

1. Push the **Trigger Menu** front-panel button.

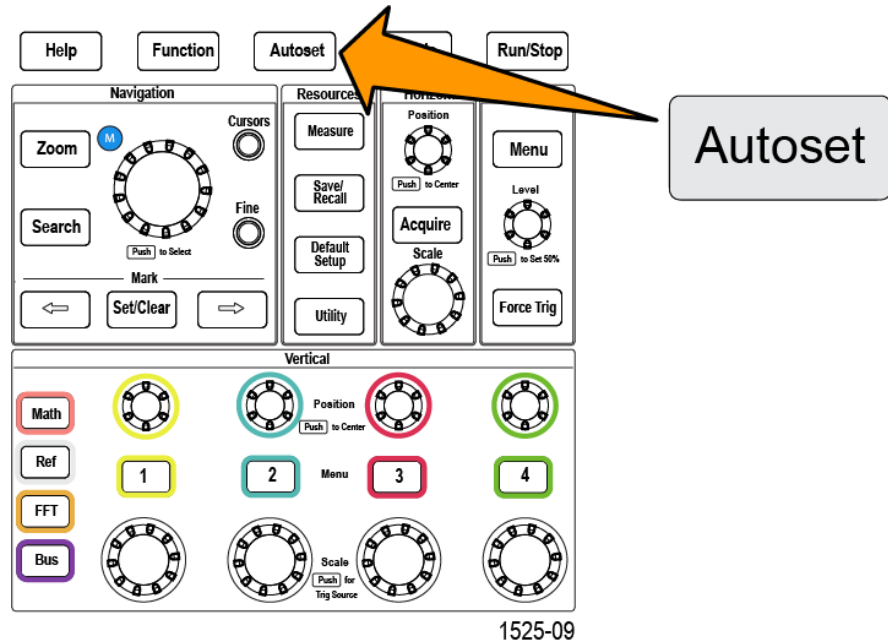

2. Push the **Type** side-menu button.
3. Use the **Multipurpose** knob to select and click **Edge**.
4. Push the **Source** side-menu button and use the **Multipurpose** knob to select and click the channel to use as the trigger signal source, or select **AC Line** to use the AC power source frequency as the trigger signal.
5. Push the **Coupling** side-menu button and use the **Multipurpose** knob to select and click the trigger coupling. See [Trigger coupling](#) on page 45.
6. Push the **Slope** side-menu button to select between rising and falling slope edges on which to trigger the oscilloscope.

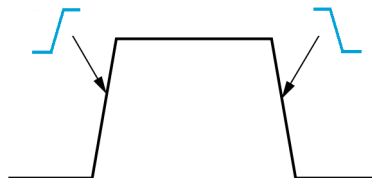

7. Push the **Level** side-menu button and use the **Multipurpose** knob to select and click the trigger level entry method:
  - Click **Level** and use the **Multipurpose** knob to manually set the trigger level.
  - Click **Choose Preset** and use the **Multipurpose** knob to set the trigger level to a predefined signal logic family level (TTL, CMOS, ECL, and so on) or to 0.
  - Click **Set to 50%** to set the trigger level to 50% of the signal peak-to-peak level.

---

**NOTE.** You can use the **Trigger Level** knob to immediately change the trigger level and momentarily display a long horizontal line (or two lines for a **runt** trigger) across the waveform to show the trigger level(s) in relation to the waveform.

---

Push the **Trigger Level** knob to immediately set the trigger to 50% of the signal peak-to-peak level.

## Triggering on a specified pulse width

Use this procedure to set the oscilloscope to trigger on a specified signal pulse condition. You can trigger when a pulse is less than, greater than, equal to, or not equal to a set time period (width). The minimum pulse width setting is 1 ns. See [Available trigger types](#) on page 44.

Pulse width triggering is most often used to troubleshoot or analyze digital signals.

1. Push the **Trigger Menu** front-panel button.

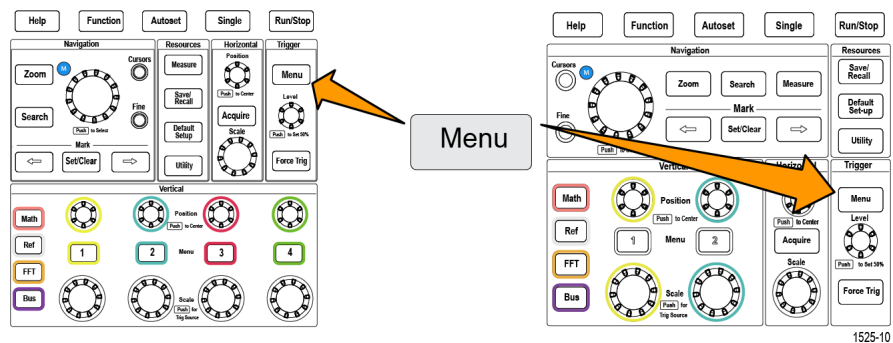

2. Push the **Type** side-menu button.
3. Use the **Multipurpose** knob to select and click **Pulse Width**.
4. Push the **Source** side-menu button and use the **Multipurpose** knob to select and click the channel to use as the trigger signal source, or select **AC Line** to use the AC power source frequency as the trigger signal.
5. Push the **Polarity** side-menu button and use the **Multipurpose** knob to select and click the pulse polarity (positive or negative) to trigger on.
6. Push the **Threshold** side-menu button and use the **Multipurpose** knob to select and click the trigger level entry method:
  - Click the threshold field and use the **Multipurpose** knob to manually set the trigger level.
  - Click **Choose Preset** and use the **Multipurpose** knob to set the trigger level to a predefined signal logic family level (TTL, CMOS, ECL, and so on) or to 0.
  - Click **Set to 50%** to set the trigger level to 50% of the signal peak-to-peak level.
7. Push the **Trigger When** side-menu button and use the **Multipurpose** knob to select and click the pulse width condition on which to trigger. Then use the **Multipurpose** knob to enter the pulse width time parameter.

## Triggering on a runt pulse

Use this procedure to set the oscilloscope to trigger when a runt pulse occurs. You can also trigger when a runt pulse is less than, greater than, equal to, or not equal to a set time period (width).

A runt pulse is a pulse that crosses one threshold level but fails to cross a second threshold before recrossing the first. Therefore, a runt trigger needs two threshold levels to define the two levels that a signal must pass through to be considered a valid (nonrunt) signal. See [Available trigger types](#) on page 44.

Runt pulse triggering is most often used to troubleshoot or analyze digital signals.

The minimum runt pulse width setting is 1 ns.

1. Push the **Trigger Menu** front-panel button.

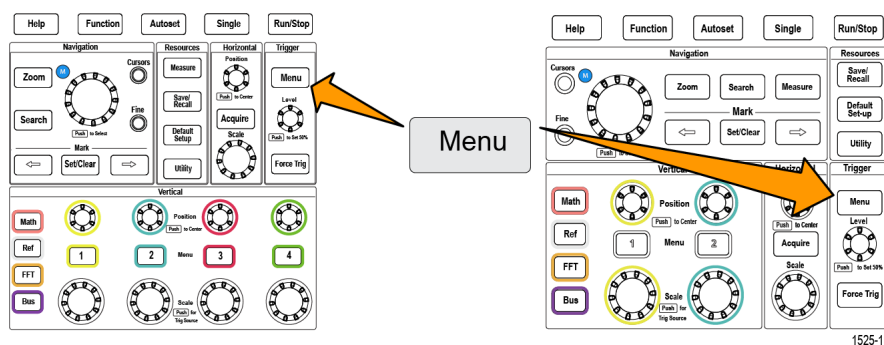

1525-10

2. Push the **Type** side-menu button.
3. Use the **Multipurpose** knob to select and click Runt.
4. Push the **Source** side-menu button and use the **Multipurpose** knob to select and click the channel to use as the trigger signal source, or select **AC Line** to use the AC power source frequency as the trigger signal.
5. Push the **Polarity** side-menu button and use the **Multipurpose** knob to select and click the runt pulse polarity (positive, negative, or either) to trigger on.
6. Push the **Thresholds** side-menu button and use the **Multipurpose** knob to select and click the trigger levels (thresholds) to use to detect a runt pulse:
  - Click **High** and use the **Multipurpose** knob to manually set the level that defines a valid high signal threshold level.
  - Click **Low** and use the **Multipurpose** knob to manually set the level that defines a valid low signal threshold level.
  - Click **Choose Preset** and use the **Multipurpose** knob to set the trigger threshold levels to predefined signal logic family levels (TTL, CMOS, ECL, and so on) or to 0.
7. Push the **Trigger When** side-menu button and use the **Multipurpose** knob to select and click **Runt Occurs** to trigger on any runt event. If triggering on a

runt width, use the **Multipurpose** knob to select and click the runt pulse width condition to test for, and enter the runt width time parameter.

## Setting the trigger mode

Use this procedure to set the oscilloscope trigger **Mode**. The trigger mode sets how the oscilloscope behaves in the absence or presence of a trigger. Trigger mode also enables the trigger holdoff function. See [Trigger modes](#) on page 45.

Trigger mode does not set the trigger conditions; those are set with the **Trigger Type** side-menu buttons.

1. Push the **Trigger Menu** front-panel button.

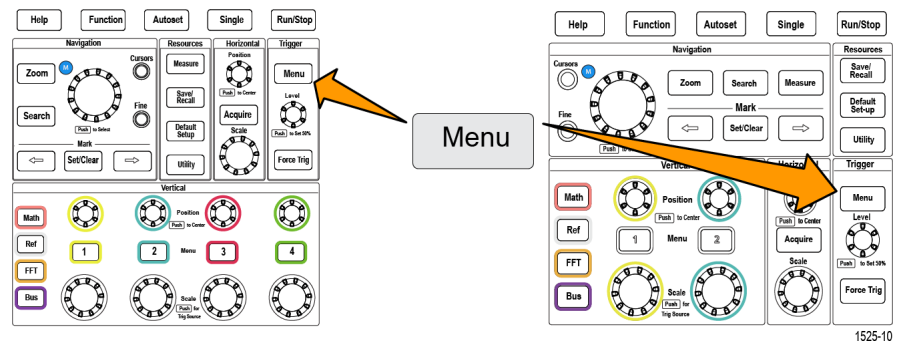

2. Push the **Mode** side-menu button.
3. Use the **Multipurpose** knob to select and click a trigger mode or holdoff mode:
  - Click **Auto (Untriggered Roll)** to set the oscilloscope to acquire and display a waveform even if a trigger does not occur. If there is no valid triggering event, the waveform will appear to roll across the screen. See [Auto Untriggered Roll trigger mode](#) on page 45.
  - Click **Normal** to set the oscilloscope to acquire and display a waveform only when a valid trigger event occurs. See [Normal trigger mode](#) on page 46.
  - Click **Holdoff** to set a time period after a trigger event, during which the oscilloscope ignores new trigger events. Once the holdoff period is over, the oscilloscope starts looking for the trigger condition. The minimum holdoff period is 20 ns. See [Holdoff trigger mode](#) on page 46.





---

# Acquisition setup

This section describes procedures for setting the oscilloscope acquisition parameters.

## Using Autoset

**Autoset** is a fast way to acquire and display a waveform. **Autoset** automatically sets the trigger type to edge, sets the threshold level to 50% of the signal level, and analyzes the input signal and adjusts the oscilloscope acquisition, horizontal, and vertical settings to display five to six waveform cycles. **Autoset** is ideal for quickly displaying a repeating signal waveform.

Complete the following steps to Autoset:

1. Connect a probe to the oscilloscope and signal source.
2. Push the **Vertical Menu** button for the channel input that you want to **Autoset**, to enable that channel.

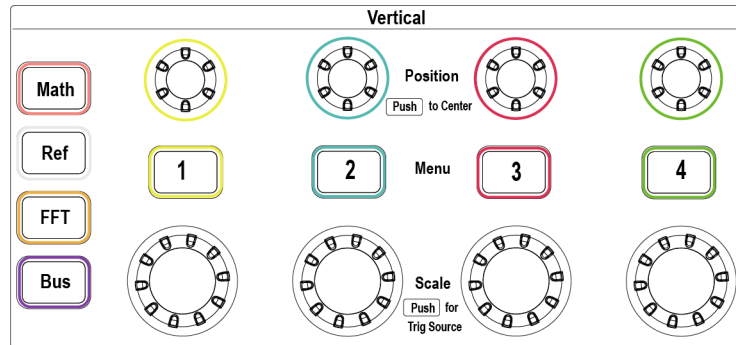

1525-27

3. Push **Autoset**. The oscilloscope takes a few moments to analyze and display the signal.
4. You can push the **Undo Autoset** side-menu button to undo the last Autoset.

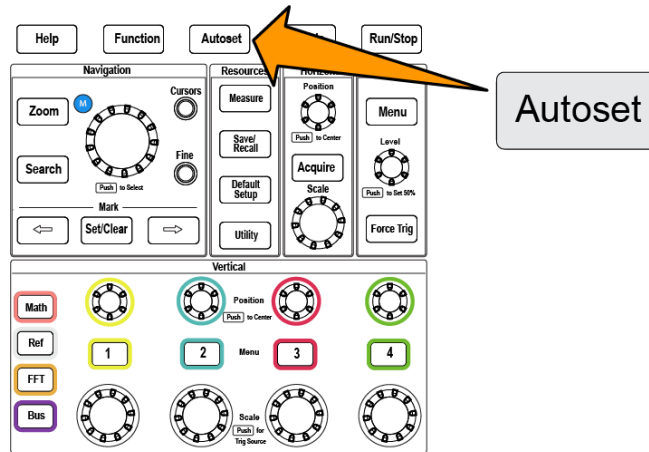

1525-09

## Autoset tips

- If more than one channel is active, **Autoset** triggers on the lowest-numbered displayed channel, and displays all active channels from the top to the bottom of the screen.
- Autoset always sets vertical offset to 0 V.
- Channel 1 is a special case: If all channels are off (not displayed), or channel 1 is on, **Autoset** attempts to detect, trigger, and display the waveform for channel 1 even if no signal is present (resulting in a flat waveform for channel 1). It will not trigger on, or display the other channels, even if there are signals present on those channels.

## How to enable/disable Autoreset in the oscilloscope

Use this procedure to enable/disable the Autoreset function to set up a waveform manually.

**NOTE.** To disable or enable the Autoreset function requires a password. The default factory password is 000000.

1. Push **Utility**.

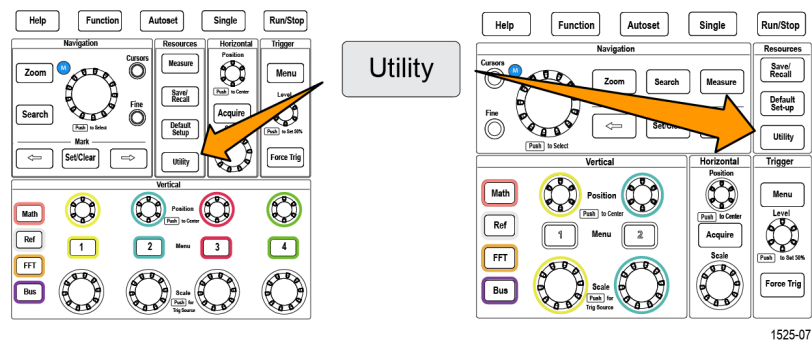

2. Push **-More- Page 1/2** side-menu button.
3. Push **Feature Enable** side-menu button.

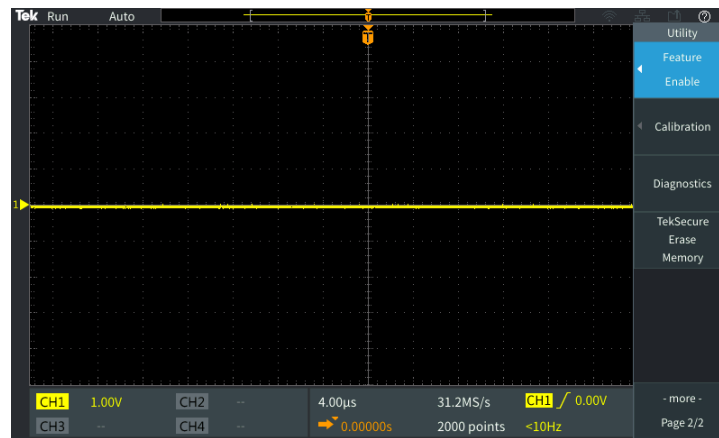

- Use the **Multipurpose** knob to select and click **Autoset Enable**. The oscilloscope opens the **Feature Enable** password entry screen.

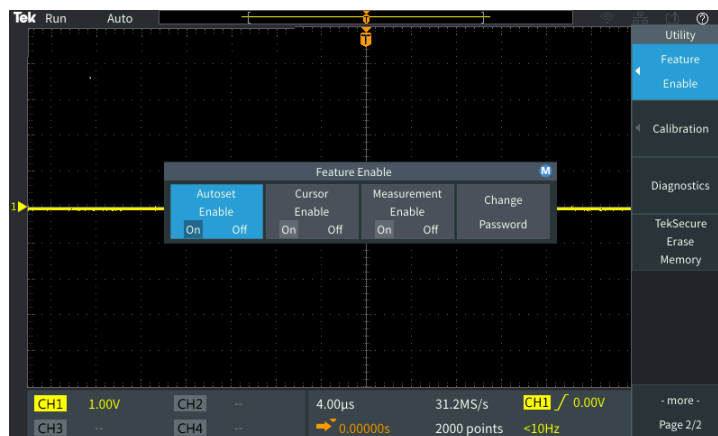

- Use the **Multipurpose** knob and side-menu buttons to enter the password that lets you disable Autoset. The factory default password is **000000**.
- Push **OK** side-menu button to enter the password and let you disable Autoset.

## How to change the Autoset password

Use this procedure to change the Autoset enable/disable password. Autoset requires a password to enable or disable the Autoset mode.

- Push **Utility**.

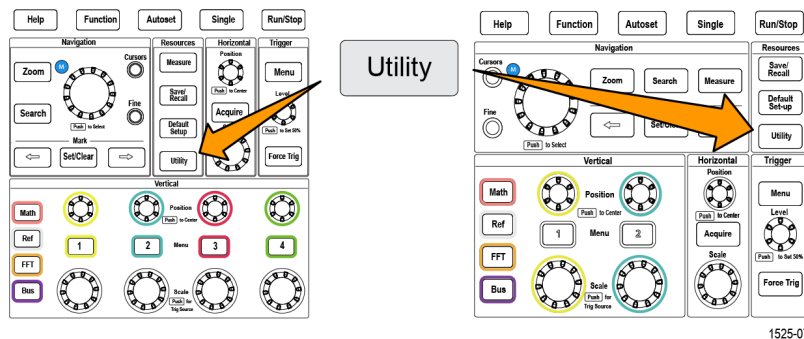

- Push **-More- Page 1/2** side-menu button.
- Push **Feature Enable** side-menu button.
- Use the **Multipurpose** knob to select and click **Autoset Enable**.

5. Use the **Multipurpose** knob to select and click **Change Password**. The oscilloscope opens the **Change Password** entry screen.

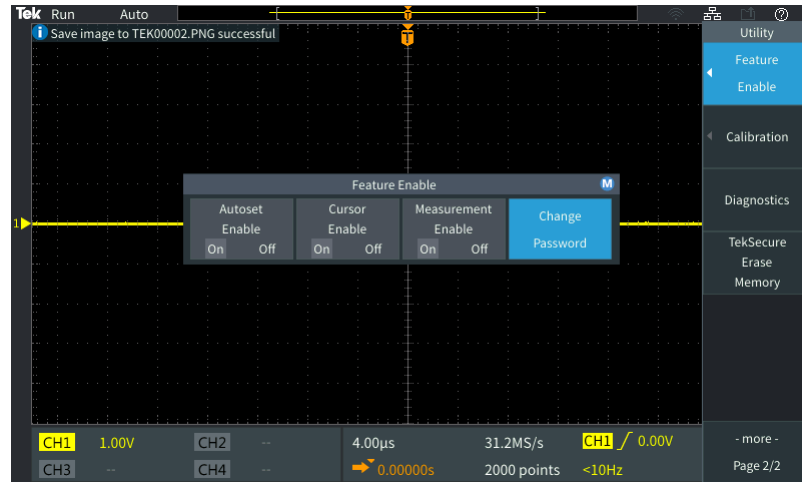

6. Use the **Multipurpose** knob and side-menu buttons to select alphanumeric and enter characters for the current password. Then push the **OK** side-menu button. The factory default password is 000000.
7. Use the **Multipurpose** knob and side-menu buttons to enter the new password. Then push the **OK** side-menu button. Reenter the new password to confirm it and push the **OK** side-menu button.

---

**NOTE.** *The Autoset enable/disable can be done using the PI commands. Refer Programmer manual for detailed instructions.*

---

## Starting and stopping an acquisition

After you have defined the acquisition and trigger parameters, start acquiring and displaying a waveform with the **Run/Stop** or **Single** controls.

- Push **Run/Stop** to start acquisitions (button turns green). The oscilloscope acquires repeatedly until you push the button again to stop the acquisition, or push the **Single** button.

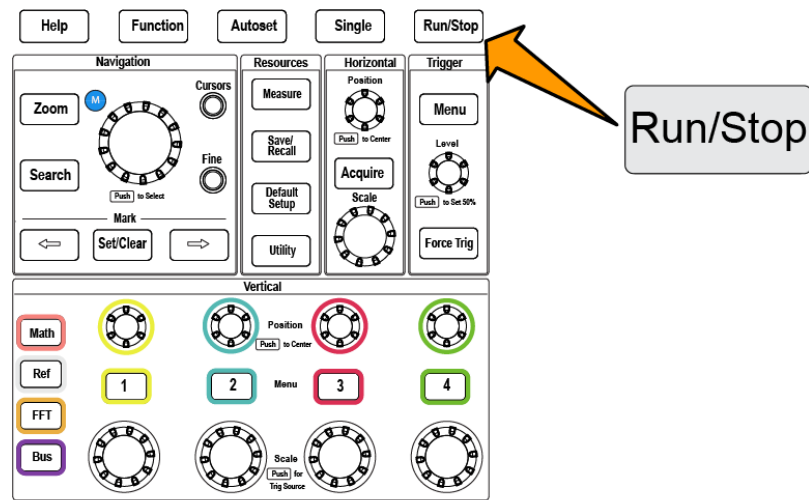

1525-11

- Push **Single** to take a single acquisition.

Single sets the trigger mode to **Normal** for the single acquisition.

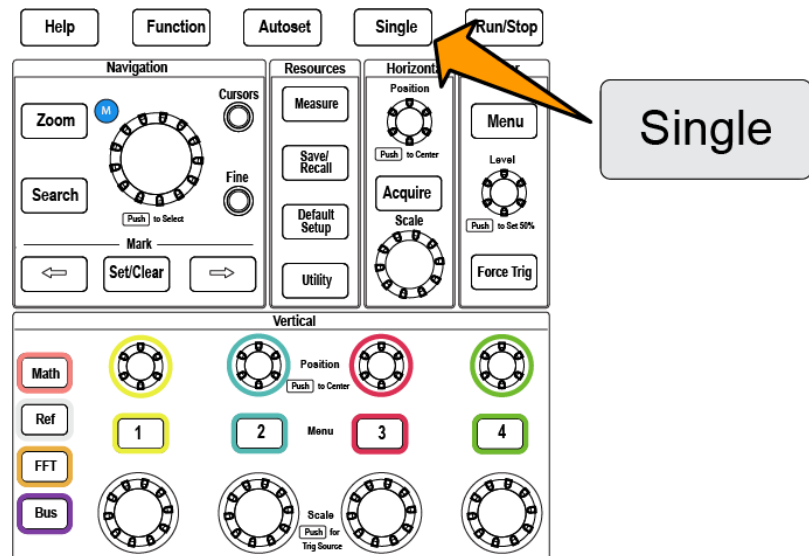

1525-12

## Setting the acquisition mode

Use the **acquisition mode** to set how the oscilloscope uses the sampled data points in each acquisition interval to create and display a waveform. See [Acquisition mode concepts](#) on page 39.

1. Push **Acquire**.

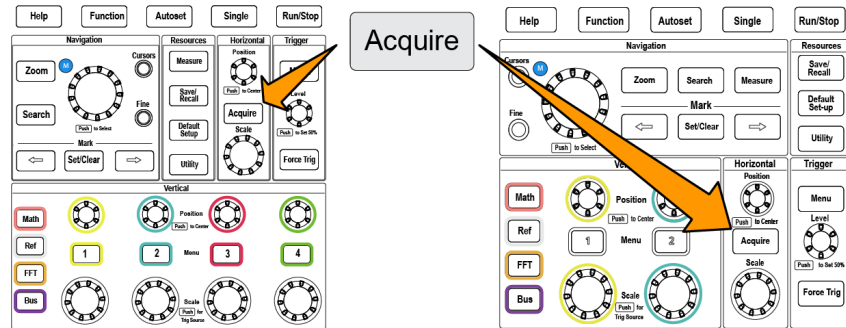

1525-13

2. Push the **Mode** side-menu button.
3. Turn the **Multipurpose** knob to select a mode (**Sample**, **Peak Detect**, **Hi res**, **Average**), then click the **Multipurpose** knob to enable that mode.
4. If you select **Average**, use the **Multipurpose** knob to select of how many acquisitions to average to create the waveform.



## Setting the acquisition trigger delay time

### 1. Push Acquire.

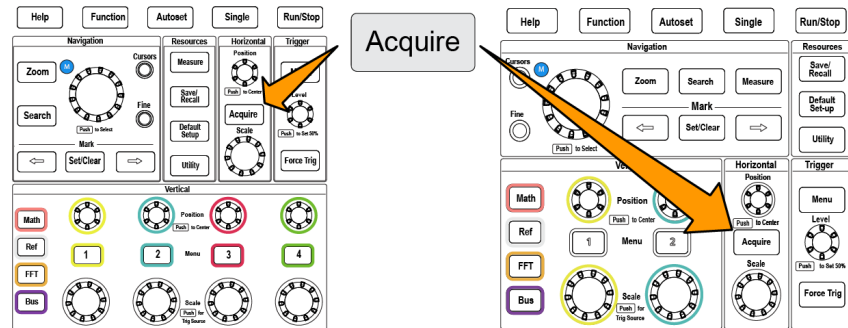

1525-13

2. Push the **Delay** side-menu button to toggle between On and Off. When set to **Off**, the expansion point is tied to the trigger point so that horizontal scale changes are centered around the trigger point.

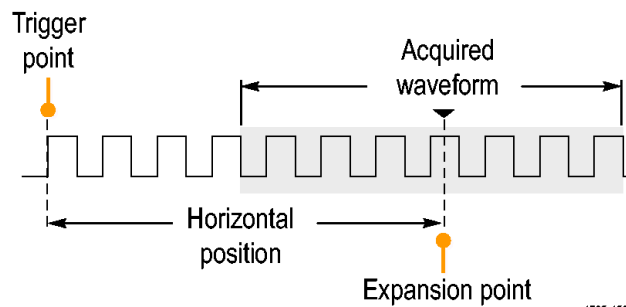

1785-159

3. With **Delay** set to **On**, the trigger point is disconnected from the expansion point. Turn the **Horizontal Position** knob to move the trigger point away from the expansion point (center graticule). The amount of delay is shown in the Horizontal Status area at the bottom-center of the graticule, referenced to 0 s (center graticule).

The trigger point can move off the screen; when this happens, the trigger marker changes to show the direction of the trigger point.

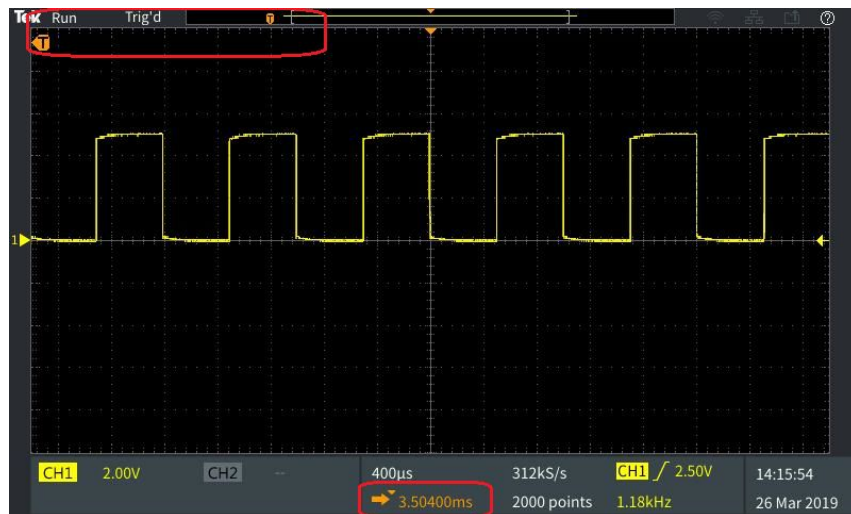

4. Once you are displaying a waveform area of interest at the center of the screen, adjust the **Horizontal Scale** knob to acquire more points for the area of interest, and use the controls to view more detail.
5. Push the **Set Horizontal Position to 0s** side-menu button to return the trigger point to the center of the waveform record (setting delay to 0). Pushing this button does not turn off the delay mode.

You can also push the front-panel **Horizontal Position** knob to return the trigger point to the center of the waveform record.

**Trigger Delay** is different than **Trigger Holdoff**. See [Holdoff trigger mode](#) on page 46.

## Setting the record length

Use this procedure to set the record length. The record length sets how many samples (data points) are added to a waveform record. Available record lengths are 1000; 2000; 20,000; 200,000; 2 million (2M), and 5 million (5M) points.

### 1. Push **Acquire**.

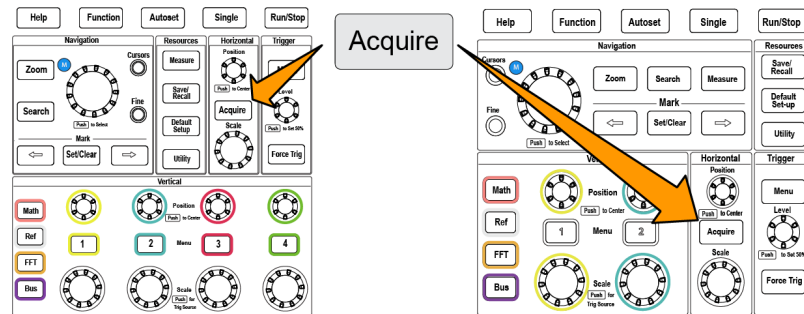

1525-13

### 2. Push the **Record Length** side-menu button.

### 3. Use the **Multipurpose** knob to select and set the record length.

Use longer record lengths to either capture more samples for a waveform record, or capture more cycles of a waveform, then use the **Zoom** controls to investigate the waveform in more detail.



**Maximum zoomed waveform record captured with 5000 points**



**Using the roll display mode**

Roll mode gives a display similar to a strip chart recorder, in that the waveform moves slowly, or rolls, from right to left on the screen. Roll mode is used to display low-frequency signals. Roll mode lets you see acquired data points without waiting for the acquisition of a complete waveform record.

Roll mode is not a button- or menu-selected mode, but is present when the trigger mode is Auto and the horizontal scale and record lengths are set as follows:

**Table 5: Roll mode is enabled when:**

Horizontal scale setting	Record length (number of samples)
40 ms/div	1000, 2000, 20k, 200k, 2M
400 ms/div	5M

## Roll mode tips

- Push **Run/Stop** to halt Roll mode.
- Roll mode is disabled under the following conditions:
  - When using **Reference**, **Math**, or **FFT** waveforms
  - Using the **Zoom** and **Search** function
  - Taking measurements (**Measure** menu)
  - When trigger mode is changed to **Normal**
  - When horizontal scale is set to 40 ms/division or higher (for 5 M record lengths, this is limited to 400 ms/division or higher)

---

**NOTE.** *The **Average** acquisition mode is unavailable when you are using Roll mode.*

---

## Setting the oscilloscope to factory default values - Default Setup

**Default Setup** clears the current oscilloscope settings and loads factory-defined settings. This lets you quickly reset the oscilloscope to a known state before setting up to take a new measurement.

See [Setting the oscilloscope to factory default values - Default Setup](#) on page 80.

To return the oscilloscope to its factory default settings:

### 1. Push **Default Setup**.

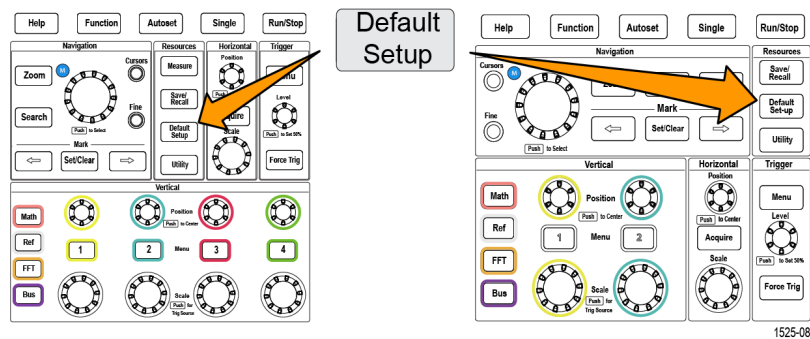

### 2. If you change your mind, push **Undo Default Setup** side-menu button to return the oscilloscope to the settings present before you pushed **Default Setup**. You must push this button before doing any other action.

# Waveform display settings

This section contains concepts and procedures for displaying and removing a waveform.

## Displaying and removing a waveform

Use this procedure to turn on or off the display of each channel's waveform.

To add or remove a waveform from the display, push the corresponding front-panel channel **Menu** button.

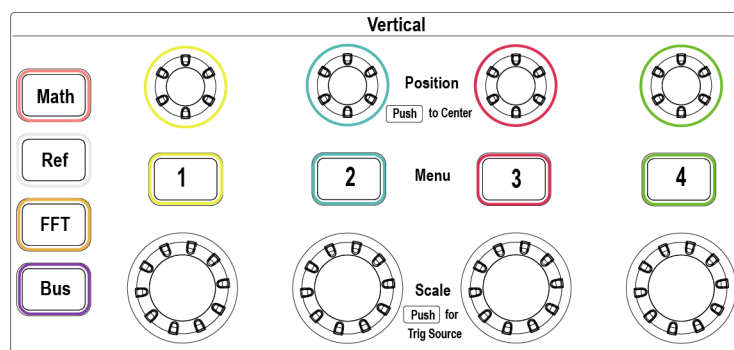

1525-27

If the selected channel is already active, pushing the channel **Menu** button removes the waveform.

If the channel is not active, pushing the channel **Menu** button selects that channel; another push removes the waveform from the screen.

If more than one waveform is displayed on the screen, selecting a channel draws the corresponding waveform on top of all other waveforms.

## Setting the waveform persistence

Persistence sets the time for how long the oscilloscope retains and displays the sampled waveform points on the screen. Using longer or infinite persistence time helps to display infrequent or random signal anomalies such as glitches.

Normal persistence sets the oscilloscope to erase the current waveform data as it draws the newest acquisition. Changing the persistence time (from 1 second to 10 seconds) sets how long to retain waveform data points in memory and on the screen until they are erased. The older data points are erased first.

Infinite persistence sets the oscilloscope to retain and display all acquisition waveform data points without erasing the previous data.

Changing an acquisition setting, such as Horizontal Position or Scale, Autoset, and Single, resets the persistence period to start over.

### 1. Push **Acquire**.

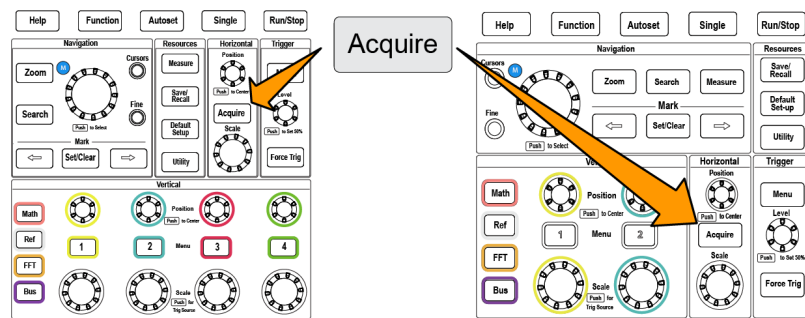

1525-13

### 2. Push **Waveform Display** side-menu button.

### 3. Use the **Multipurpose** knob to select and click **Persist Time**.

### 4. Use the **Multipurpose** knob to change and set the **Persist Time** value. The range is **Auto** 0 s - 10 s (in one second increments), and infinity.

Auto is not same as 0 seconds. Auto is persistence time that gives the most number of waveforms per second, for a given horizontal scale. The range of persistence is 1s - 10s in the steps of 1s. There is an option to have persistence set to 0 seconds. This is mode can be enabled when Persistence is set to OFF. When persistence is set to ON, there is an option to select the amount of persistence in terms of time ranging from 1s -10s. Further, the amount of persistence can be set to Auto, that gives the best performance.

### 5. To clear the persistence of the displayed waveform, select and click **Clear Persistence**. This does not change the persistence setting, but just clears the displayed waveform persistence data.



## Waveform persistence tip

To quickly clear the displayed waveform persistence data, push **Single**, then push **Run/Stop** to restart active waveform acquisition.

## The XY display mode

The XY display mode plots the signal amplitude of channel 1 (X) against the amplitude of channel 2 (Y), where channel 1 is the horizontal axis and channel 2 is the vertical axis. XY display mode is useful for showing signal phase or frequency relationships between periodic signals. The resulting XY plots are called Lissajou patterns.

You can display Ch 1 versus Ch 2 on two-channel models and Ch 3 versus Ch 4 on four-channel models.

1. Select the two signal sources that you want to plot. Push the **Vertical Position** knob for each channel to set the ground reference of both signals to 0 V (center horizontal graticule) so that the XY plot is centered on the screen.

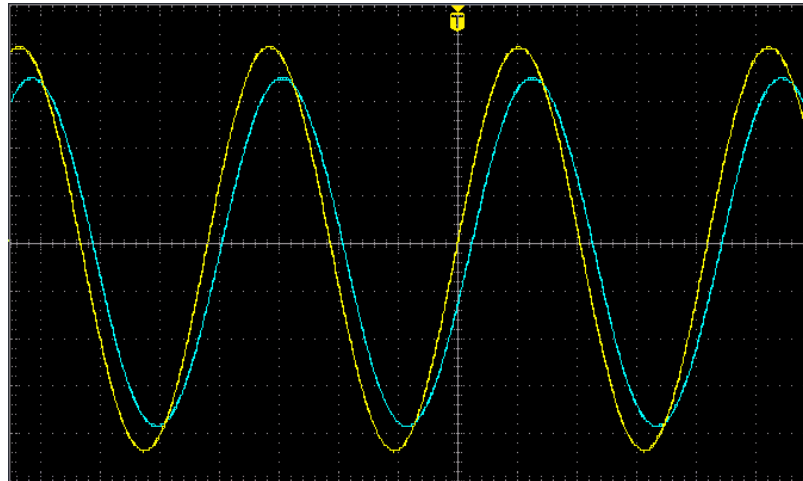

2. Push **Acquire**.

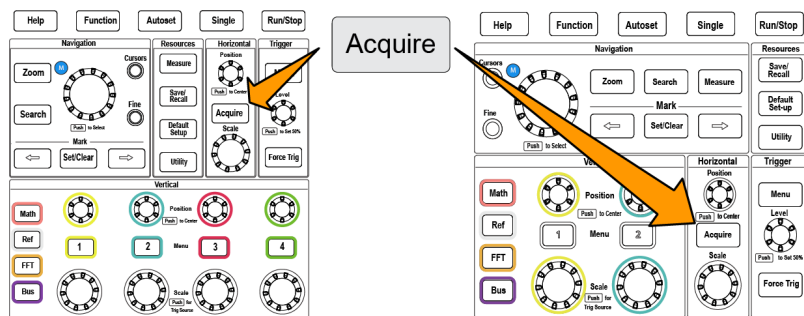

1525-13

3. Push **XY Display** side-menu button to toggle XY display mode **On** and **Off**.

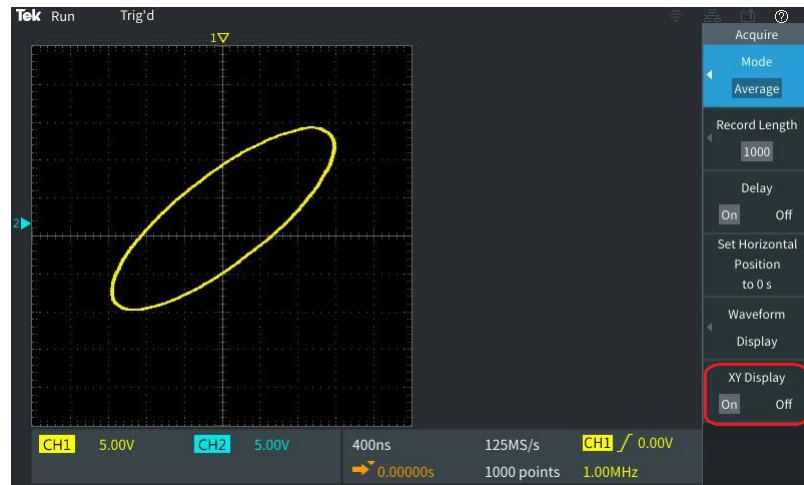

## XY display mode tips

- Because the XY display is simply a different way of displaying pairs of waveforms, the underlying waveforms are available for measurements, and for saving to reference memory or a USB drive for off-line analysis.
- Use a Web browser and search on the keyword “lissajou patterns” to find more information on XY plots.

## Setting the backlight intensity

Use this procedure to change the overall screen lighting level. Higher settings are better for brightly lighted areas, and lower values are better for dimly lit areas.

### 1. Push **Utility**.

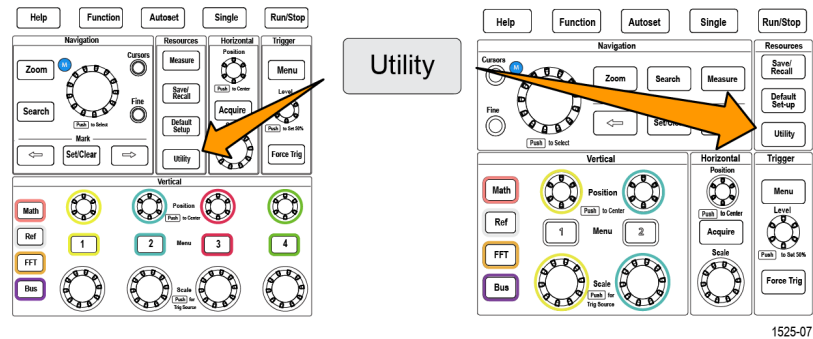

2. Push the **Display** side-menu button.
3. Use the **Multipurpose** knob to select and click **Backlight Intensity**.
4. Use the **Multipurpose** knob to change and set the backlight value.



# Analyzing a waveform

After having properly set up the acquisition, triggering, and display of your waveform, you can then analyze the results. Select from features such as displaying automatic measurements, using cursors to measure specific parts of a waveform, using math to perform an operation on two waveforms, and using FFT to display the frequency components of a signal. You can also use **Gating** to analyze only a specified part of a waveform when you take measurements. See [Taking a measurement on just a part of the waveform Gating](#) on page 99.

## Taking automatic measurements

Automatic measurements are a way to quickly take common measurements on a waveform, such as signal frequency, period, rise and fall times, and so on. You can take up to a total of six measurements at once, on any combination of input channels and a math waveform. The measurements are shown on the main screen in the order they were selected.

To take an automatic measurement:

1. Acquire and display a triggered waveform.
2. Push **Measure**.
3. Push the side-menu button to select the channel on which to take measurements.

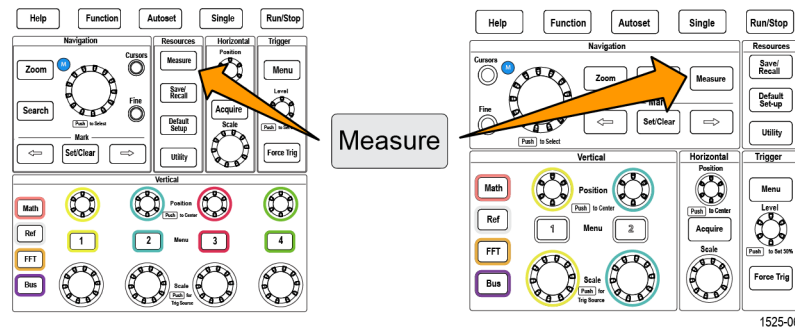

4. Use the **Multipurpose** knob to select and click a measurement. See [Automatic measurement descriptions](#) on page 92.

The **Measurement Selection** bar at the top of the screen updates to show that a measurement was selected for that channel (indicated by color), up to a maximum of six measurements total to display.

5. Measurements with a down triangle contain a list of the input channels to use for that measurement when selected. Select and click the input channels. Then push the **Menu On/Off** button to close the list.

6. To unselect a measurement, highlight that measurement and click the **Multipurpose** knob. To deselect a measurement for a different channel than the current channel, push the side-menu button for the channel of the measurement, then use the knob to select and click the measurement to remove it.
7. To unselect all measurements, push the **Remove All Measurements** side-menu button.
8. To close the measurement menu and show the selected measurements on the screen, push the **Menu On/Off** button.



Measurements are shown on the screen. Pushing the **Menu On/Off** button also turns on or off showing the measurements on the screen.

CH1	Frequency	312.4kHz
CH1	Period	3.200μs
CH2	Frequency	624.9kHz
CH2	Period	1.600μs

## Automatic measurements tip

A  symbol appears next to a measurement if a vertical signal clipping condition exists. Part of the waveform is above or below the upper or lower edge of the screen. Signal clipping causes inaccurate measurements. To obtain an accurate measurement, turn the **Vertical Scale** and **Position** knobs so that all of the waveform is on the screen.

A  symbol appears next to a measurement if the measurement accuracy is not guaranteed. Wait for measurement module to get proper measurement. As soon as the proper measurement is available, the symbol will disappear.



## Taking a measurement snapshot

The **Snapshot** measurement (in the **Measurement** menu) displays all single-channel measurements on one screen for a single acquisition of one channel. You can view the snapshot results and save a screen image of the snapshot measurements to a file.

To take a measurements snapshot:

1. Acquire and display a triggered waveform.
2. Push **Measure**.

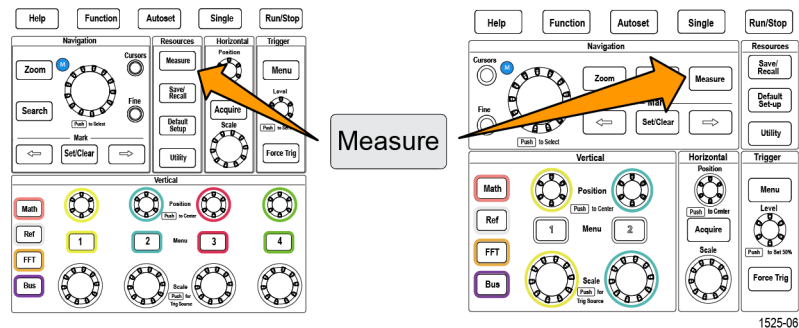

3. Push the side-menu button of the channel for which to show the measurement snapshot. You can only take a snapshot of one channel at a time.
4. Use the **Multipurpose** knob to select and click **Snapshot**. The snapshot screen opens immediately.
5. If the **File Save** button is set to save an image, push the **File Save** button to save the snapshot image to a file. See [Saving files to USB with the Save File button](#) on page 133.



6. Push the **Menu On/Off** button to close the **Snapshot** screen and return to the measurements menu.



## Snapshot measurement tip



- The measurement snapshot does not mark a measurement if a vertical clipping condition exists. Clipping is where part of the waveform is above or below the display. To obtain a proper measurement snapshot, use the **Vertical Scale** and **Position** knobs to make all of the waveform appear in the display.
- You can also use **Gating** to analyze only a specified part of a waveform when you take a measurement snapshot. See [Taking a measurement on just a part of the waveform Gating](#) on page 99.

## Automatic measurement descriptions

The following tables list the automatic measurements, grouped as shown on the measurements menu. Measurement descriptions can also be shown on the oscilloscope by enabling **Help Everywhere** (**Help > Help Everywhere**). See [Getting on-screen help for settings - Help Everywhere](#) on page 33.

## Frequency measurement descriptions

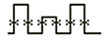
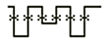
**Table 6: Frequency measurements**



Measurement		Description
Frequency		The first cycle in a waveform or gated region. Frequency is the reciprocal of the period; it is measured in hertz (Hz) where one Hz is one cycle per second.
+Pulses		The number of positive pulses that rise above the mid reference crossing in the waveform or gated region.
-Pulses		The number of negative pulses that fall below the mid reference crossing in the waveform or gated region.
+Edges		The number of positive transitions from the low reference value to the high reference value in the waveform or gated region.
-Edges		The number of negative transitions from the high reference value to the low reference value in the waveform or gated region.

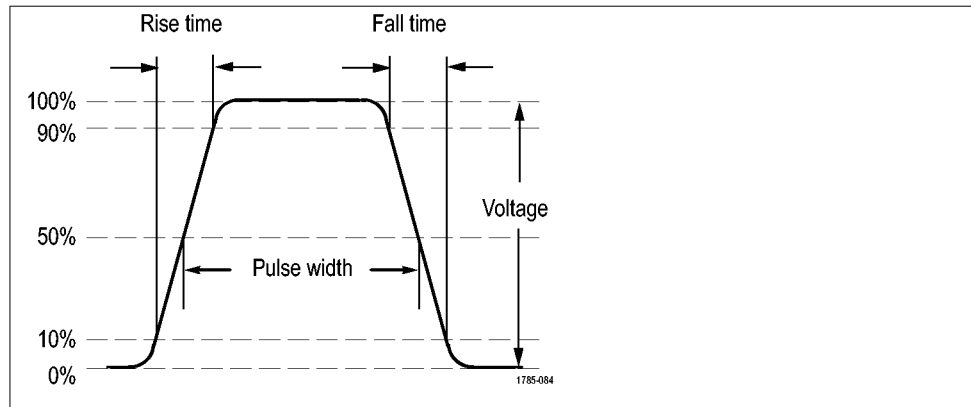

## Time measurement descriptions

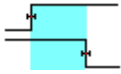
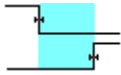
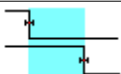

**Table 7: Time measurements**

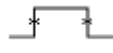
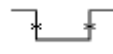
Measurement		Description
Period		The time required to complete the first cycle in a waveform or gated region. Period is the reciprocal of frequency and is measured in seconds.
Rise Time		The time required for the leading edge of the first pulse in the waveform or gated region to rise from the low reference value to the high reference value of the final value.
Fall Time		The time required for the falling edge of the first pulse in the waveform or gated region to fall from the high reference value to the low reference value of the final value.
DelayRR		The time between the mid reference (default 50%) amplitude point of the rising edge of two different waveforms. See also <i>Phase</i> . This measurement requires inputs from two channels.

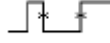

Measurement		Description
DelayRF		The time between the mid reference (default 50%) amplitude point of the rising edge of one waveform and the falling edge of a second waveforms. See also <i>Phase</i> . This measurement requires inputs from two channels.
DelayFR		The time between the mid reference (default 50%) amplitude point of the falling edge of one waveform and the rising edge of a second waveforms. See also <i>Phase</i> . This measurement requires inputs from two channels.
DelayFF		The time between the mid reference (default 50%) amplitude point of the falling edge of one waveform and the falling edge of a second waveforms. See also <i>Phase</i> . This measurement requires inputs from two channels.
Phase		The amount of time that one waveform leads or lags another waveform, expressed in degrees, where 360° makes up one waveform cycle. See also <i>Delay(RR, RF, FR, FF)</i> . This measurement requires inputs from two channels.
+Width		Positive pulse width. The distance (time) between the mid reference (default 50%) amplitude points of a positive pulse. The measurement is made on the first pulse in the waveform or gated region.
-Width		Negative pulse width. The distance (time) between the mid reference (default 50%) amplitude points of a negative pulse. The measurement is made on the first pulse in the waveform or gated region.



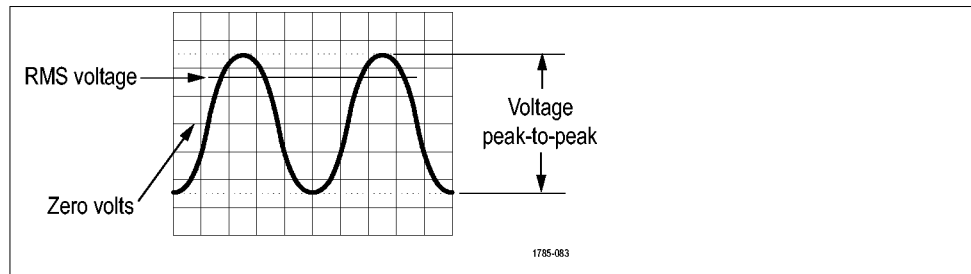

Measurement		Description
+Duty		The ratio of the positive pulse width to the signal period expressed as a percentage. The duty cycle is measured on the first cycle in the waveform or gated region.
-Duty		The ratio of the negative pulse width to the signal period expressed as a percentage. The duty cycle is measured on the first cycle in the waveform or gated region.
Burst Width		The duration of a burst (a series of transient events) and is measured over the entire waveform or gated region.

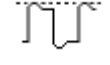

## Amplitude measurement descriptions

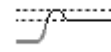

**Table 8: Amplitude measurements**



Measurement		Description
Peak-to-peak		The absolute difference between the maximum and minimum amplitude in the entire waveform or gated region.
Amplitude		The average high value less the average low value measured over the entire waveform or gated region.
Max		The most positive peak voltage. Max is measured over the entire waveform or gated region.

Measurement		Description
Min		The most negative peak voltage. Min is measured over the entire waveform or gated region.
High		This value is used as 100% whenever high reference, mid reference, or low reference values are needed, such as in fall time or rise time measurements. Calculated using either the min/max or histogram method. The min/max method uses the maximum value found. The histogram method uses the most common value found above the midpoint. This value is measured over the entire waveform or gated region.
Low		This value is used as 0% whenever high reference, mid reference, or low reference values are needed, such as in fall time or rise time measurements. Calculated using either the min/max or histogram method. The min/max method uses the minimum value found. The histogram method uses the most common value found below the midpoint. This value is measured over the entire waveform or gated region.
+Over		This is measured over the entire waveform or gated region and is expressed as: Positive Overshoot = (Maximum – High) / Amplitude x 100%.
–Over		This is measured over the entire waveform or gated region and is expressed as: Negative Overshoot = (Low – Minimum) / Amplitude x 100%.
Mean		The arithmetic mean over the entire waveform or gated region.

Measurement		Description
Cycle Mean		The arithmetic mean over the first cycle in the waveform or the first cycle in the gated region.
RMS		The true Root Mean Square voltage over the entire waveform or gated region.
Cycle RMS		The true Root Mean Square voltage over the first cycle in the waveform or the first cycle in the gated region.

## Area measurement descriptions

**Table 9: Area measurements**

Measurement		Description
Area		A voltage over time measurement. The measurement returns the area over the entire waveform or gated region in volt-seconds. Area measured above ground is positive; area measured below ground is negative.
Cycle Area		A voltage over time measurement. The measurement is the area over the first cycle in the waveform or the first cycle in the gated region expressed in volt-seconds. The area above the common reference point is positive, and the area below the common reference point is negative.



## Taking a measurement on just a part of the waveform Gating

**Gating** sets the automatic measurements to use only a specified part of a waveform for the measurements. The **Gating** function applies to all channels and all measurements (in other words, you cannot set a different gating region for individual measurements or different channels).

### 1. Push Measure.

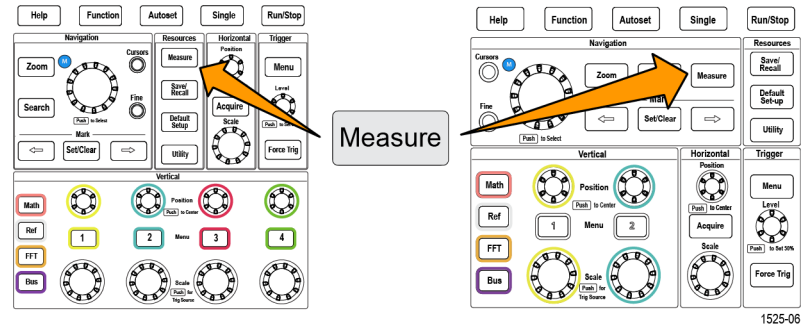

### 2. Push the **Gating** side-menu button.

### 3. Use the **Multipurpose** knob to select and click the area of the waveform to use for taking measurements (**Off (Full Record)**, **Screen**, **Between Cursors**)

If selecting **Between Cursors**, use the **Multipurpose** knob to select and move the gating cursors to mark the waveform area to use for automatic measurements.

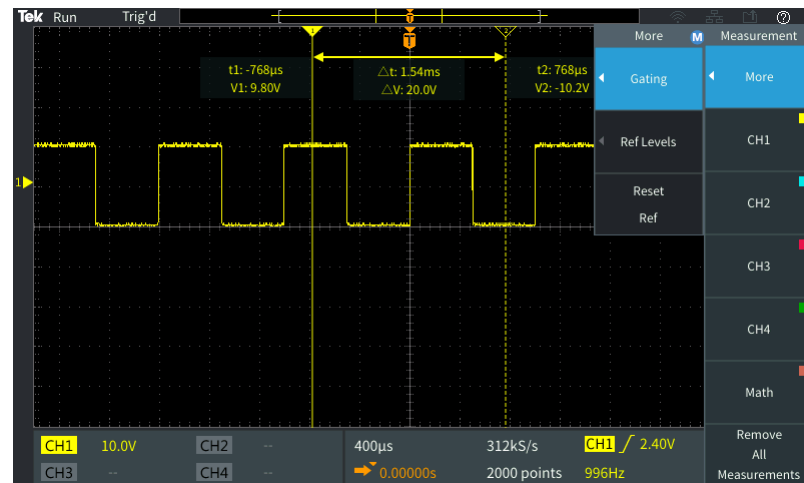

## How to enable / disable measurement in the oscilloscope

Use this procedure to enable / disable waveform measurements manually.

**NOTE.**

- To disable or enable the measurement function requires a password. The default factory password is 000000.
- An instructor in a TekSmartlab™ equipped education lab can enable or disable Measurement from the TekSmartLab application, for all the connected oscilloscopes.

1. Push **Utility**.

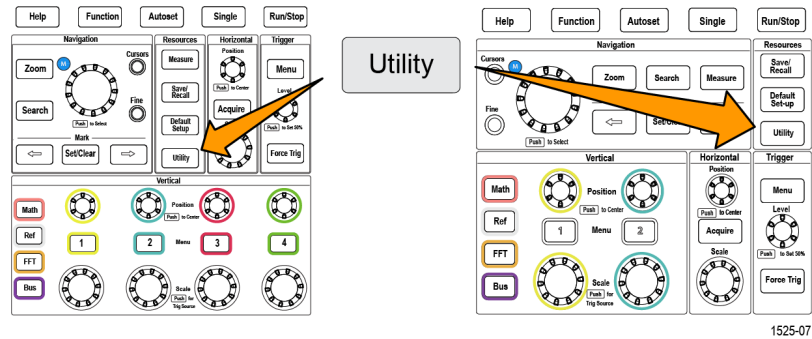

2. Push **-More- Page 1/2** side-menu button.
3. Push **Feature Enable** side-menu button.
4. Use the **Multipurpose** knob to select and click **Measurement Enable**. The oscilloscope opens the **Feature Enable** password entry screen.



5. Use the **Multipurpose** knob and side-menu buttons to enter the password that lets you disable Measurement.

- Push **OK** side-menu button to enter the password and let you disable Measurement.

## How to change the measurement password

Use this procedure to change the Measurement password. The measurement requires a password to enable or disable the measurement function.

- Push **Utility**.

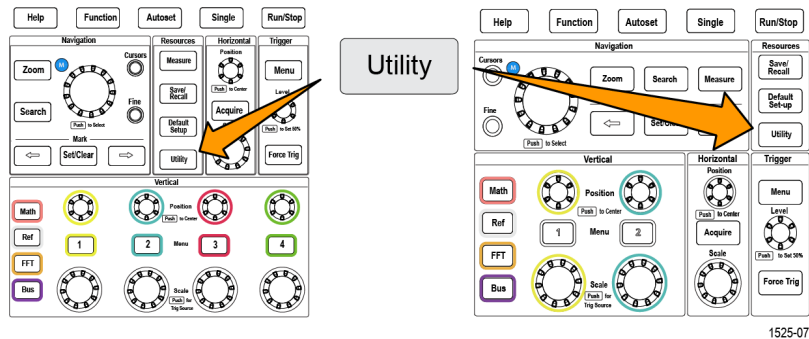

1525-07

- Push **-More- Page 1/2** side-menu button.
- Push **Measurement Enable** side-menu button.
- Use the **Multipurpose** knob to select and click **Change Password**. The oscilloscope opens the **Change Password** entry screen.

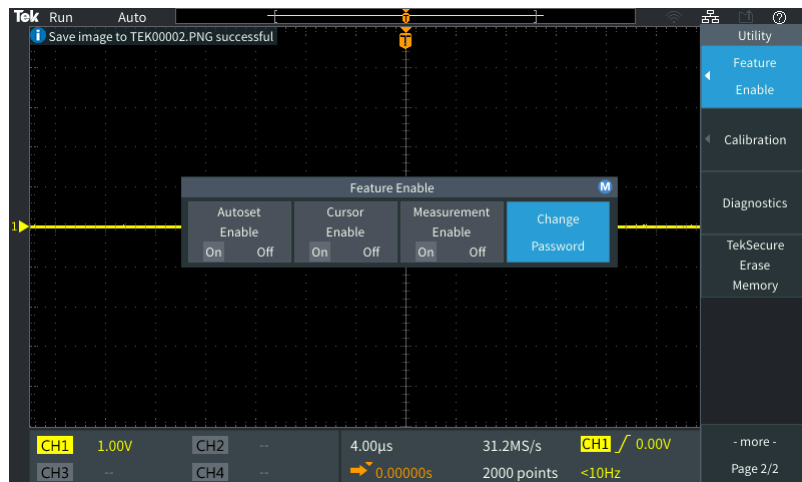

- Use the **Multipurpose** knob and side-menu buttons to select the alphanumeric and enter characters for the current password.
- Push **OK** side-menu button.

7. Use the **Multipurpose** knob and side-menu buttons to enter the new password to confirm it.
8. Push **OK** side-menu button.

---

**NOTE.** *The measurement password can be changed using the PI commands. Refer to Programmer manual for detailed instructions.*

---

## Using cursors to take manual measurements

Cursors are on-screen vertical and horizontal lines that you position on a waveform to take measurements. The cursors have readouts that show the value at their position or where they cross a waveform. Cursors also show the absolute difference measurement value (or delta) between two cursor positions.

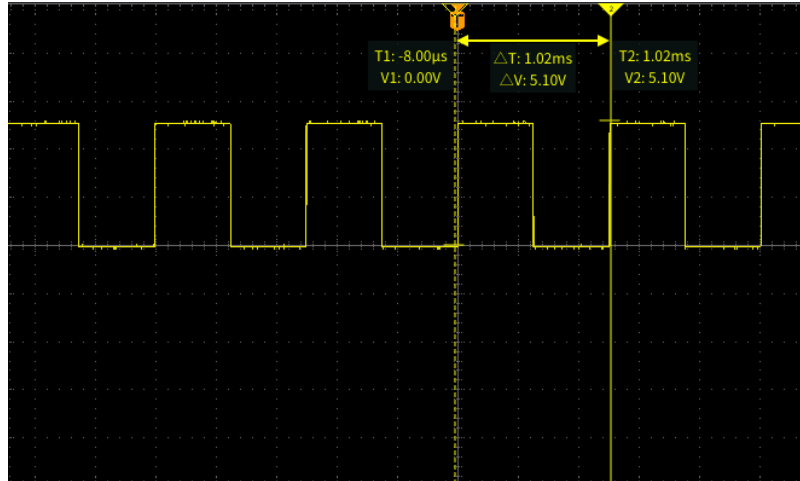

Cursor readouts appear next to the cursors. The readouts show the signal values at the current cursor positions. The readouts also show the difference (delta, marked with a  $\Delta$  symbol) between the cursor measurements. The oscilloscope always shows the readouts when the cursors are turned on.

**NOTE.** Cursors are not available in XY display mode.

1. Push **Cursors** to display two vertical **Time** cursors by default.

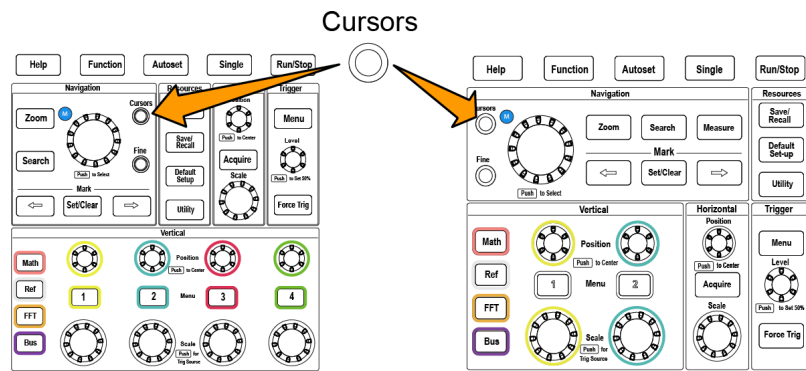

1525-19

The color of the cursors indicates the channel on which they are taking measurements.

The solid line cursor is the active (selected) cursor, and is controlled by the **Multipurpose** knob.

- Use the **Multipurpose** knob to move the solid line (selected) cursor. The readouts associated with that cursor change as you move the cursor.

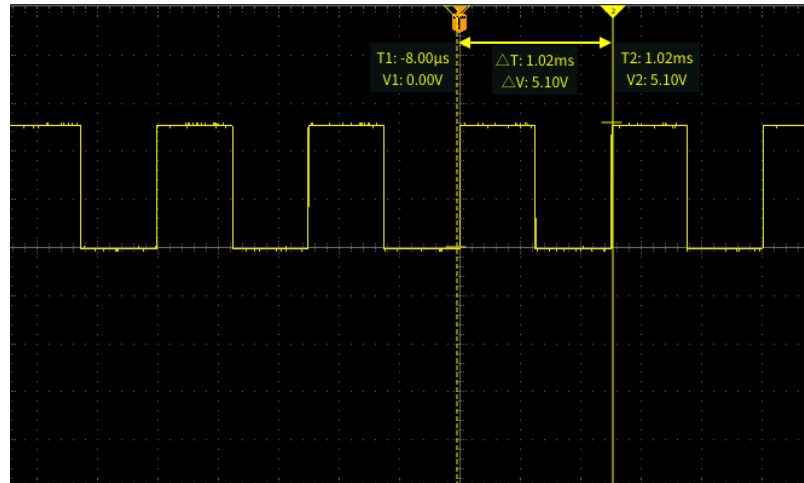

- Push the **Multipurpose** knob to select the other cursor (which becomes a solid line), then turn the knob to move that cursor. The first cursor is now drawn with a dotted line.
- To make smaller cursor position adjustments, push the **Fine** button to toggle between making coarse and fine cursor position adjustments.

The **Fine** button also enables smaller adjustments on the **Vertical** and **Horizontal Position** knobs, the **Trigger Level** knob, and many adjustment operations of the **Multipurpose** knob.

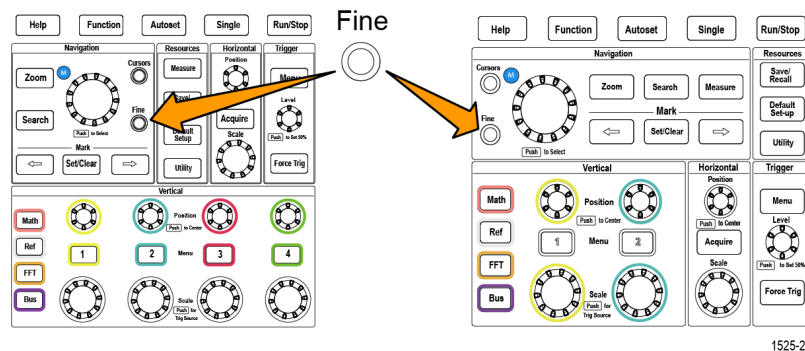

- Push the **Amplitude** or **Screen** side-menu button to select a different cursor for taking measurements. See *Cursor types* on page 106.
- Push the **Link** side-menu button to turn cursor linking **On** or **Off**. If linking is **On**, turning the **Multipurpose** knob moves both cursors at the same time.

7. If one or both of the cursors are off of the screen, push the **Bring Cursor On Screen** side-menu button to bring off-screen cursors back to the screen.
8. Push the **Cursors** front panel button to turn the cursors off.

## Cursor types

The cursor types are:

Time or Frequency cursors. These vertical cursors measure time or frequency, the signal amplitude where the cursors cross the waveform, and the absolute difference (delta) between the two cursors cross points (both time and amplitude delta).

Time readouts are relative to the trigger point (which is 0 s). For example, cursors to the left of the trigger are minus time values.



Amplitude cursors. These horizontal cursors measure vertical amplitude parameters, typically voltage.

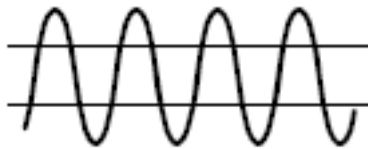

Screen cursors: A combination of both the vertical and horizontal cursors. Click the **Multipurpose** knob to cycle through selecting the cursors.

---

**NOTE.** The vertical cursors in screen mode are not tied to where the cursor crosses the waveform, and so do not show the amplitude value where they cross the signal. Amplitude values are read from the horizontal cursors.

---

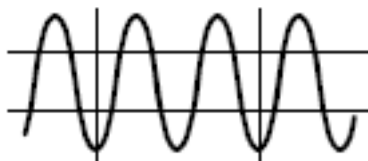



## How to enable / disable cursor in the oscilloscope

Use this procedure to enable / disable cursor manually.

**NOTE.** To disable or enable the Cursor function requires a password. The default factory password is 000000.

**NOTE.** An instructor in a TekSmartlab™-equipped education lab can enable or disable Cursor from the TekSmartLab application, for all connected oscilloscopes.

### 1. Push Utility.

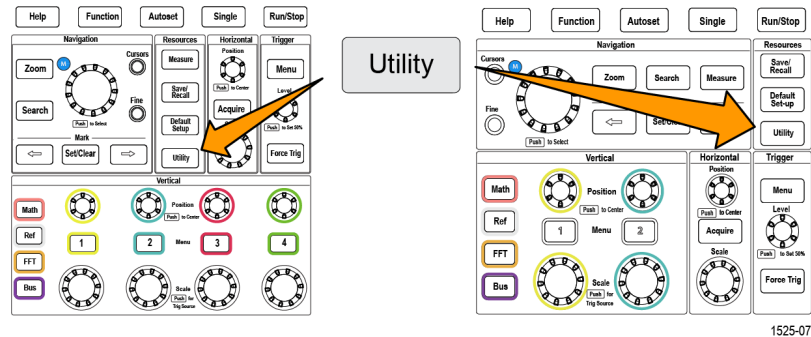

2. Push **-More- Page 1/2** side-menu button.
3. Push **Feature Enable** side-menu button.
4. Use the **Multipurpose** knob to select and click **Cursor Enable**. The oscilloscope opens the **Feature Enable** password entry screen.

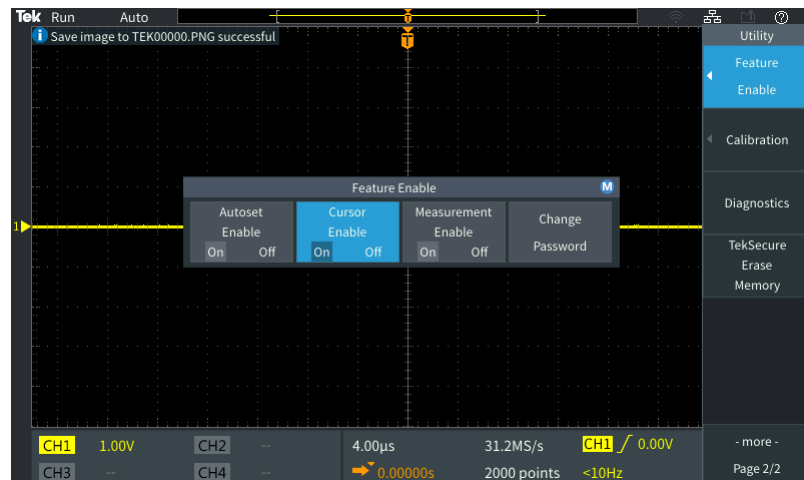

5. Use the **Multipurpose** knob and side-menu buttons to enter the password that lets you disable Cursor.
6. Push **OK** side-menu button to enter the password and let you disable Cursor.

## How to change the cursor password

Use this procedure to change the cursor password. The cursor requires a password to enable or disable the cursor function.

1. Push **Utility**.

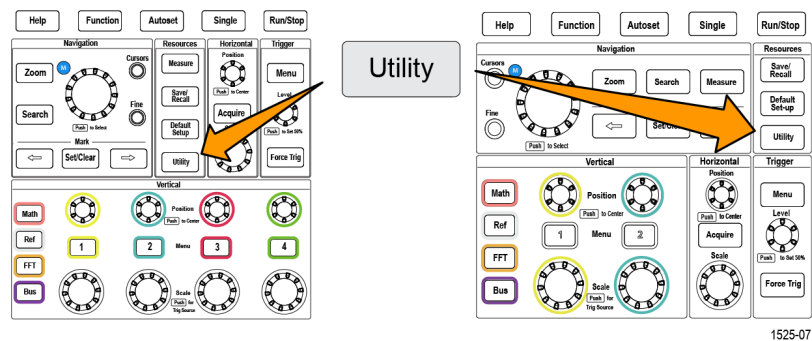

2. Push **-More- Page 1/2** side-menu button.
3. Push **Cursor Enable** side-menu button.
4. Use the **Multipurpose** knob to select and click **Change Password**. The oscilloscope opens the **Change Password** entry screen.

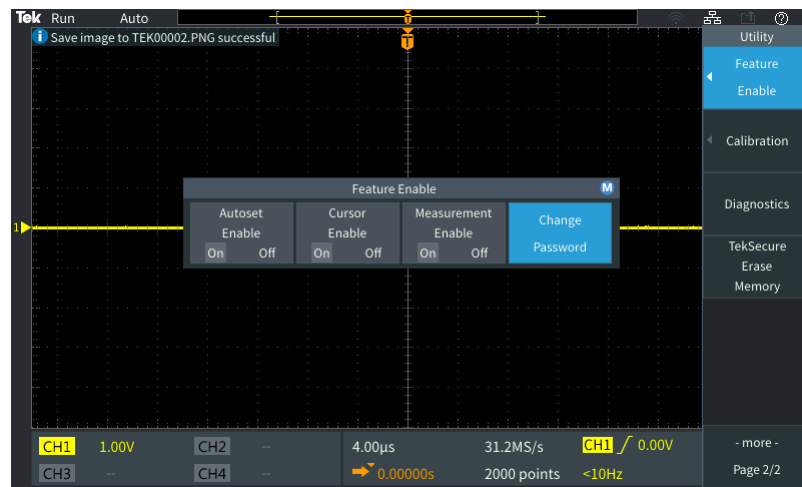

5. Use the **Multipurpose** knob and side-menu buttons to select the alphanumeric and enter characters for the current password.
6. Push **OK** side-menu button.

7. Use the **Multipurpose** knob and side-menu buttons to enter the new password to confirm it.
8. Push **OK** side-menu button.

---

**NOTE.** *The cursor password can be changed using the PI commands. Refer to Programmer manual for detailed instructions.*

---

## Creating math waveforms

Math waveforms let you add, subtract, and multiply any two channel waveforms to create a new math waveform. You can then take measurements on the math waveform, or save it to a reference memory or an external waveform data file.

1. Push **Math**. The oscilloscope displays a red math waveform using the current side menu settings.

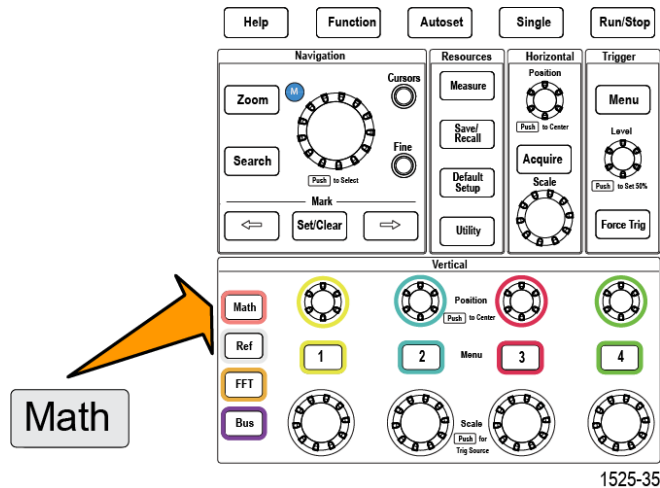

2. Push the **Source 1** side-menu button.
3. Use the **Multipurpose** knob to select and click the first channel to use for the math waveform.
4. Push the **Operator** side-menu button.
5. Use the **Multipurpose** knob to select and click the math operation to apply to the two waveforms (add, subtract, or multiply).
6. Push the **Source 2** side-menu button.
7. Use the **Multipurpose** knob to select and click the second channel to use for the math waveform. The oscilloscope immediately displays the math waveform.
8. To move the math waveform vertical position, push the **Position** side-menu button and use the **Multipurpose** knob to move the waveform.
9. To change the size (vertical scale) of the math waveform, push the **Vertical Scale** side-menu button and use the **Multipurpose** knob to change the waveform scale.

Note that the math vertical scale setting only applies to the math waveform.

An example of using a math waveform is to calculate instantaneous power (current times voltage) by multiplying a voltage waveform and a current waveform.

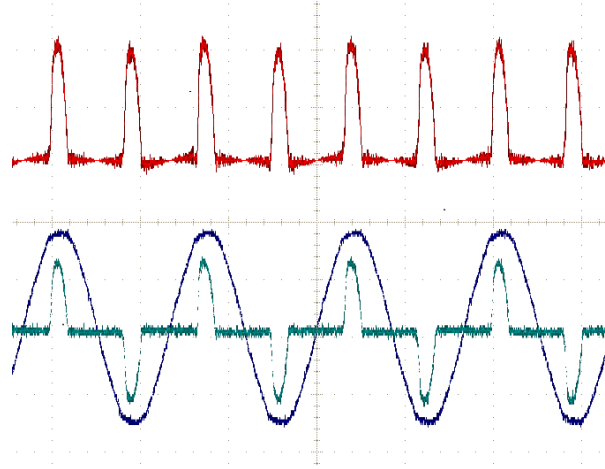

## Math waveform tips

- Math waveforms get their horizontal scale and position from the source channels. Adjusting these controls for the source waveforms also adjusts the math waveform.
- Adding or subtracting waveforms with different units sets the math waveform units to “?”.
- You can take automatic measurements on math waveforms similarly as on channel waveforms. Just select the **Math** side menu in the **Measure** screen and select the measurements to apply.
- You can save a math waveform to a reference memory or to a file on a USB drive. You can also recall (load) math waveforms into reference memory. See [Recalling waveform data](#) on page 136.
- You can zoom in on math waveforms using the **Navigation** controls (**Zoom** button and **Multipurpose** knob).

## Using FFT to see signal frequency information

There are many signals that have some sort of distortion or unwanted characteristics. Sometimes these distortions do not affect how that signal works in the circuit. But often system clock pulses, signals induced from a nearby printed circuit path, or noise from a power supply or other source can affect a signal and prevent it from operating correctly. The FFT function is a powerful tool to help you find the frequencies of unwanted signals that are embedded in your main signal.

The **FFT** function uses Fast Fourier Transformation (FFT) mathematical calculations on the waveform data to determine the component frequencies in the signal. The resulting waveform shows a series of ‘spikes’ along a horizontal axis, where each spike represents a frequency component of the waveform and its amplitude. In other words, an FFT is a basic spectrum analyzer function to analyze frequency components of a waveform.

1. Acquire and display several cycles of the waveform.

---

**NOTE.** You can only display FFT waveforms for 2000 and 20K point record length waveforms.

---

2. Push FFT button.

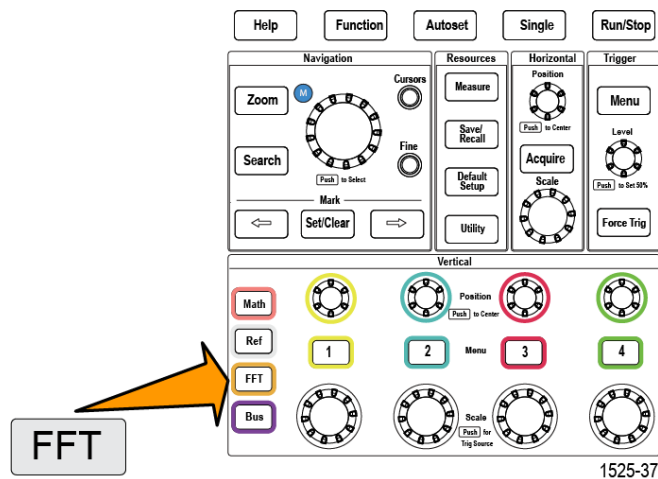

The oscilloscope shows the default FFT screen. The lower main screen shows the FFT waveform.

Use the **Vertical Position** knob of the source channel to move the **FFT** waveform up or down.

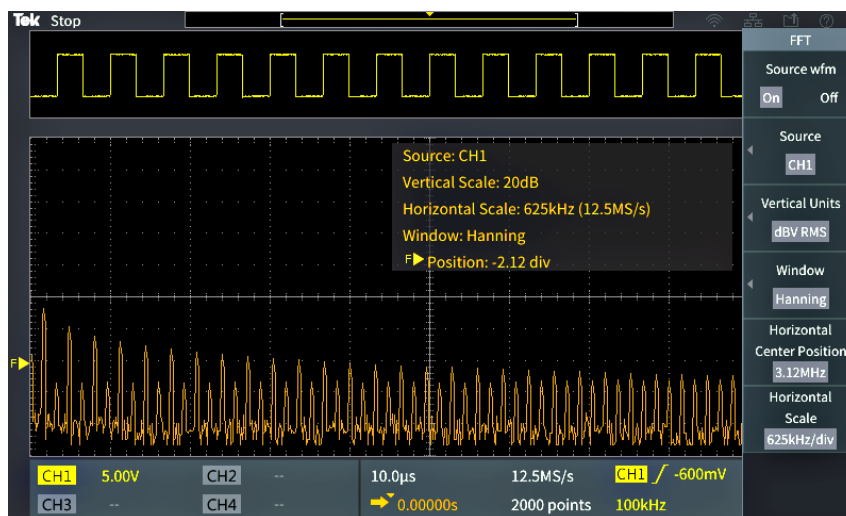

3. Push **Source wfm** side-menu button to toggle the display of the source waveform (at the top of the screen) **On** or **Off**.
4. Push the **Source** side-menu button and use **Multipurpose** knob to set the source to channel **1**, **2**, **3**, or **4**. The default source is whatever channel was selected before opening the **FFT** window.
5. Push the **Vertical Units** side-menu button and use the **Multipurpose** knob to select and click **dBV RMS** or **Linear RMS**.

Use the default **dBV RMS** **Vertical Units** scale to see a detailed view of multiple frequencies, even if the frequencies have very different amplitudes.

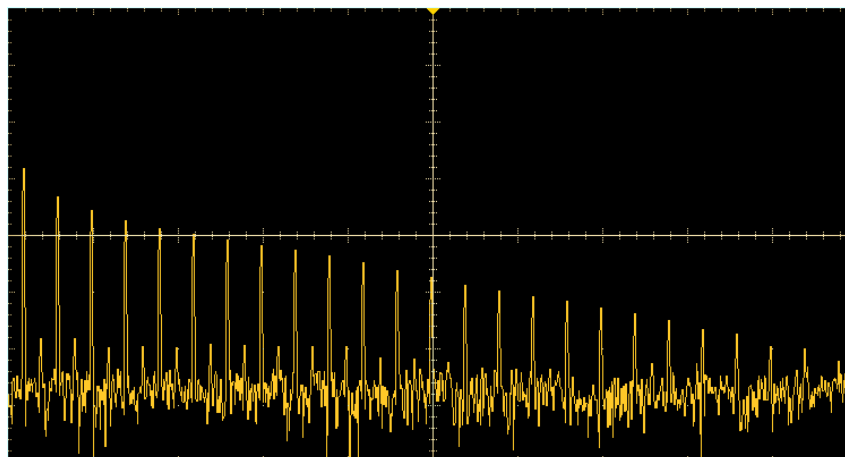

Use the **Linear RMS** vertical scale to see an overall view of how all frequencies levels compare to each other.

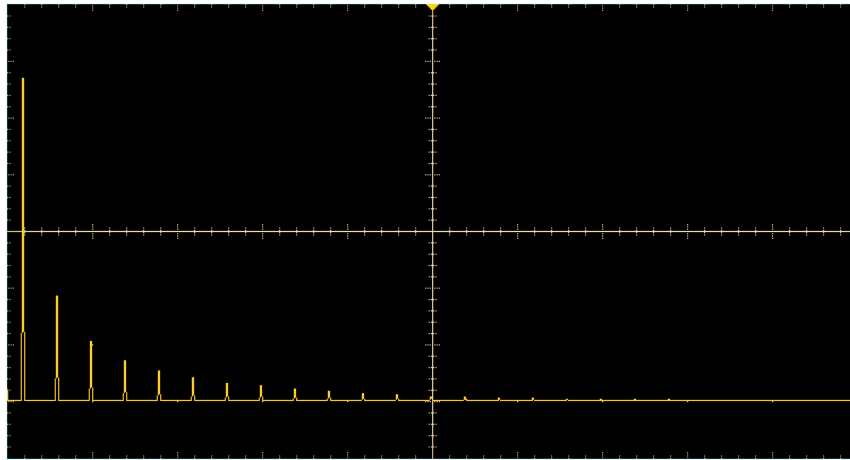

6. Push the **Window** side-menu button and use the **Multipurpose** knob to select and click **Hanning**, **Rectangular**, **Hamming**, or **Blackman-Harris**. See [About FFT windows](#) on page 116.
7. Push the **Horizontal Center Position** side-menu button and use the **Multipurpose** knob to position the FFT graph horizontally. The readout on the side menu is the frequency of the waveform point that is positioned on the center vertical graticule. Use this to quickly measure FFT ‘spike’ frequencies.

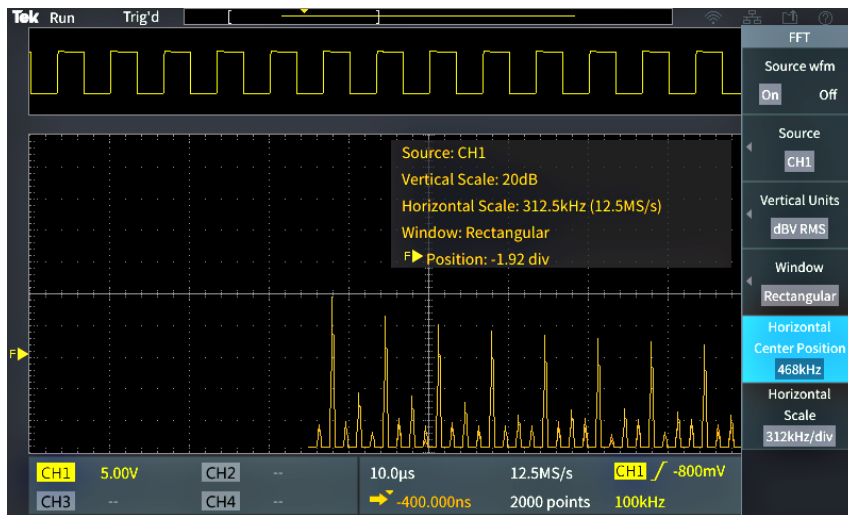



8. Push the **Horizontal Scale** side-menu button and use the **Multipurpose** knob to set the horizontal scale (frequency per major graticule division) value. Use this to expand or contract the FFT waveform to show more or less detail. The FFT waveform expands around the center cursor.

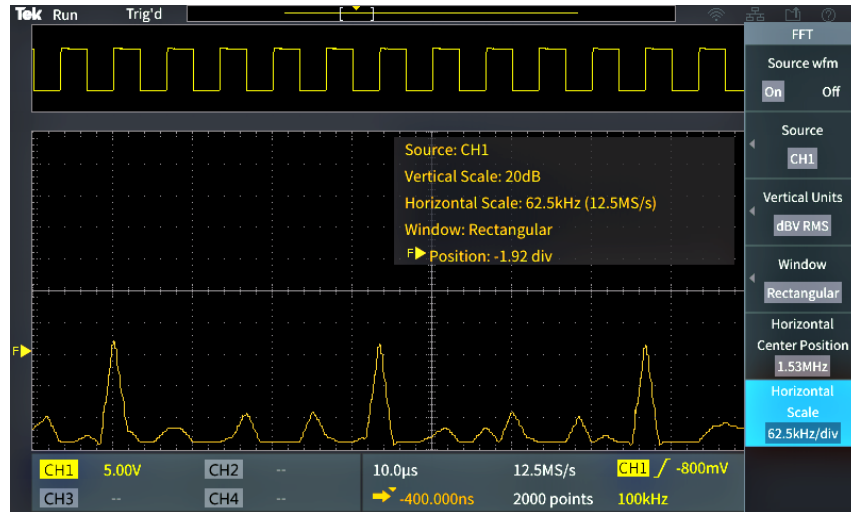

9. Push the **Cursors** front-panel button and use the cursors to take measurements.

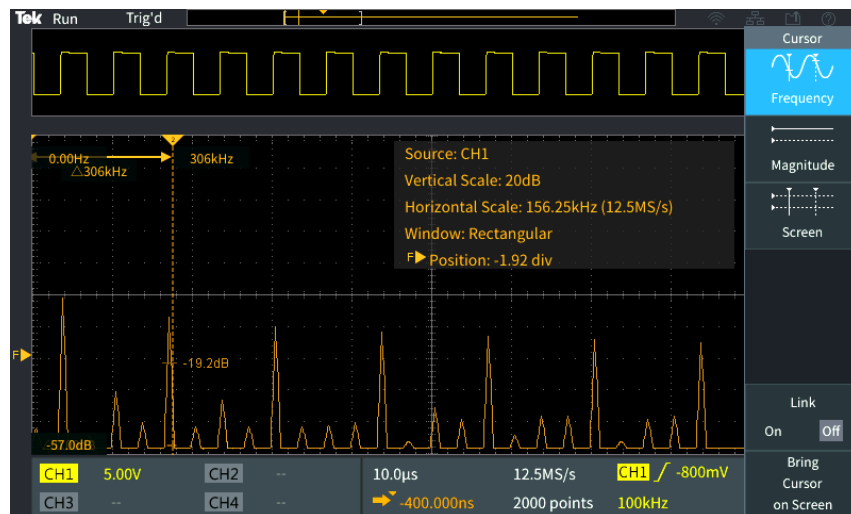

## FFT tips

- You can only display FFT waveforms for 1000, 2000 and 20K record length waveforms.
- Use the **Vertical Position** knob of the source channel to change the vertical position of the FFT waveform.
- Use the **Vertical Scale** knob of the source channel to change the vertical size of the FFT waveform.
- Use cursors to measure frequencies and relative signal levels.
- Input signals that have a DC component or offset can cause incorrect FFT waveform component magnitude values. To minimize the DC component, use **AC Coupling** on the input signal.
- To reduce random noise and aliased components See [FFT and display waveform aliasing](#) on page 119. In repetitive or single-shot events, set the oscilloscope acquisition mode to average over 16 or more samples. Average mode attenuates signals not synchronized with the trigger.
- Do not use the **Average** acquisition mode if the source signal contains frequencies of interest that are not synchronized with the trigger rate.
- For transient (impulse, one-shot) signals, set the oscilloscope trigger conditions so that the transient pulse waveform is centered in the waveform record.



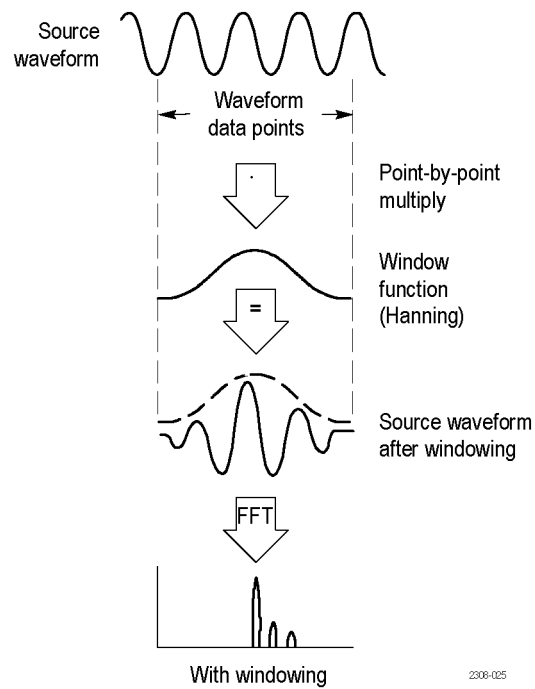

## About FFT windows

The FFT algorithm applies a ‘window’ process to the source waveform record to ‘shape’ the record so that the start and stop values for the FFT waveform are close to the same amplitude. Starting and stopping the waveform at close to the same amplitude reduces adding artificial waveform that are not present in the actual signal. Using a window on the source signal results in an FFT waveform that more accurately represents the source signal frequency components.



The different window shapes are trade-offs between frequency accuracy and magnitude accuracy. What you want to measure, and your source signal characteristics, help you to select which window to use. Use the following guidelines to select the best window for your signal analysis needs. The Hanning window is a good starting point for FFT measurements.

**Table 10: FFT windows**

Window type	Window 'shape'
<p><b>Hanning</b>                      This is a very good window for measuring amplitude accuracy but less so for resolving frequencies.                      Use Hanning for measuring sine, periodic, and narrow band random noise. This window works on transients or bursts where the signal levels before and after the event are significantly different.</p>	
<p><b>Rectangular</b>                      This is the best type of window for resolving frequencies that are very close to the same value but worst for accurately measuring the amplitude of those frequencies. It is the best type for measuring the frequency spectrum of nonrepetitive signals and measuring frequency components near DC.                      Use Rectangular for measuring transients or bursts where the signal level before and after the event are almost equal. Also, use this window for equal-amplitude sine waves with frequencies that are very close, and for broadband random noise with a relatively slow varying spectrum.</p>	
<p><b>Hamming</b>                      This is a very good window for resolving frequencies that are very close to the same value with somewhat improved amplitude accuracy over the rectangular window. It has a slightly better frequency resolution than the Hanning.                      Use Hamming for measuring sine, periodic, and narrow band random noise. This window works on transients or bursts where the signal levels before and after the event are significantly different.</p>	
<p><b>Blackman-Harris</b>                      This is the best window for measuring the amplitude of frequencies but worst at resolving frequencies.                      Use Blackman-Harris for measuring predominantly single frequency waveforms to look for higher order harmonics.</p>	

## FFT and display waveform aliasing

FFT waveform problems occur when the oscilloscope acquires a signal that contains frequency components that are greater than the Nyquist frequency (the Nyquist frequency is 1/2 of the sample rate). The frequency components that are above the Nyquist frequency are undersampled and appear to "fold back," or reflect, around the right edge of the graticule, showing as lower-frequency components in the FFT waveform. These incorrect components are called aliases.

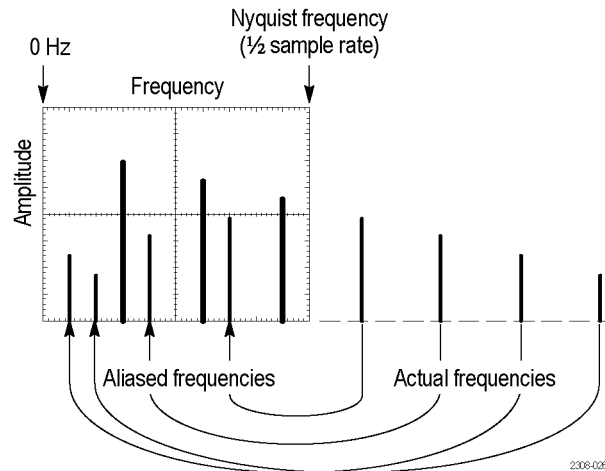

You can use the following methods to reduce or eliminate aliases:

- Increase the sample rate by adjusting the **Horizontal Scale** front-panel knob to a faster frequency setting. Since you increase the Nyquist frequency as you increase the horizontal sampling rate (samples/second), the aliased frequency components should appear at their proper frequency. If the increased number of frequency components shown on the screen makes it difficult to measure individual components, use the **Horizontal Scale** side-menu button in the FFT menu to display more detail of the FFT waveform.
- Use a filter on the input signal to limit the signal to frequencies below that of the Nyquist frequency. If the frequency components you are interested in are below the built-in 20 MHz bandwidth setting, push the **Vertical Menu** button and set the channel bandwidth to 20 MHz.

## Displaying reference waveforms

A reference waveform is a waveform that you have stored in a nonvolatile memory location on the oscilloscope. You can use a reference waveform as a standard against which to compare other waveforms.

You can save channel, math, and FFT waveforms to reference memory. Reference waveforms remain in memory when the oscilloscope is powered off.

See the *Saving waveform data* topic to learn how to save waveforms to reference memory or external files. See [Saving waveform data](#) on page 130.

1. Push the **Ref** front-panel button.

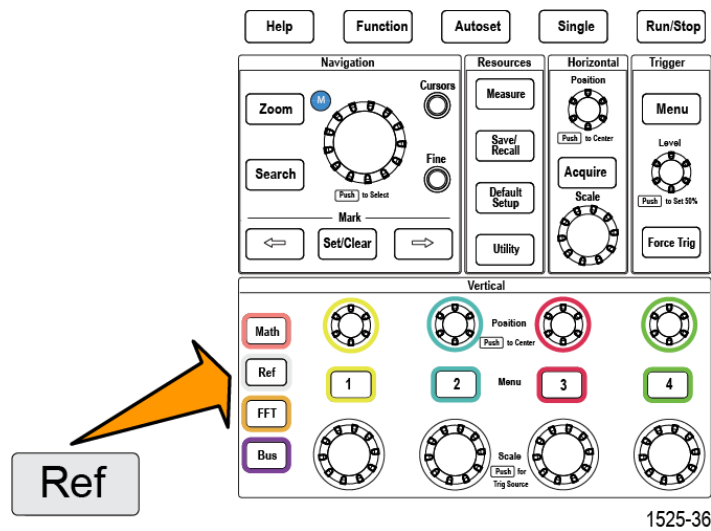

2. Push the **Ref1** or **Ref2** side-menu button to toggle displaying that waveform **On** or **Off**.

You can display both reference waveforms at the same time.

## Reference waveform tips

- You cannot position or scale a reference waveform. You should set the source waveform position and scale before saving to a reference location, so that you have space on the screen to display both the reference waveform and the live signal.
- You can use **Zoom** to show more detail on reference waveforms.

## How to view long record length waveforms Zoom

The **Navigation** controls (**Zoom** button, the **Zoom** side menu, and the **Multipurpose** knob) let you magnify and examine portions of a waveform (Ch1-Ch4, Math, Reference).

A zoomed display consists of two parts. The upper display shows the entire displayed waveform record and the position and size of the zoomed part in the waveform (in brackets) within the entire record. The lower display shows the zoomed view of the waveform (the part enclosed in brackets in the upper display).

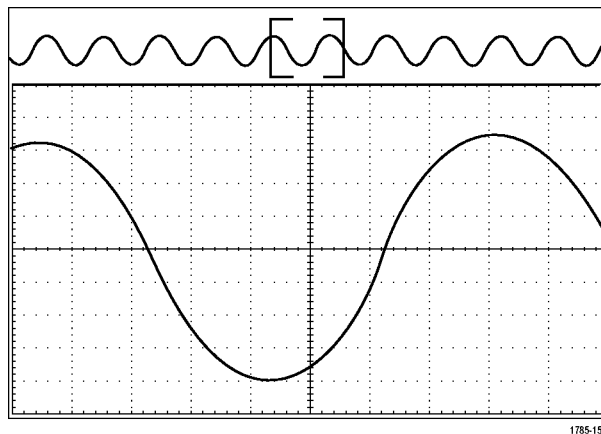

1785-154

1. Select the channel that you want to zoom.
2. Push **Zoom**.

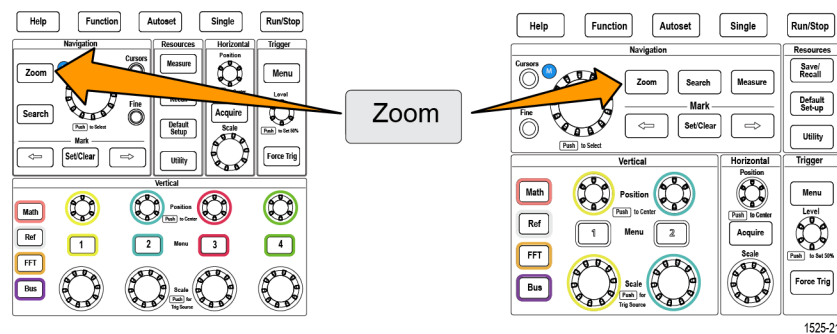

1525-21

3. Push the **Scale** side-menu button and use the **Multipurpose** knob to adjust the size of the area to zoom (magnify).
4. Push the **Position** side-menu button and use the **Multipurpose** knob to adjust the position of the zoom area in the waveform record.

## How to search and mark a waveform

You can mark locations of interest in the acquired waveform. These marks help you limit your analysis to particular regions of the waveform. You can mark areas of the waveform automatically, if they meet some special criteria, or you can manually mark each item of interest. You can use arrow keys to jump from mark to mark (area of interest to area of interest). You can automatically search and mark many of the same parameters that you can trigger on.

Search marks provide a way to mark a waveform region for reference. You can set marks automatically with search criteria. You can search for and mark regions with particular edges, pulse widths, and runts search types.

To manually set and clear (delete) marks:

1. Move (the zoom box) to the area on the waveform where you want to set (or clear) a search mark by turning the pan (outer) knob.

Push the next ( → ) or previous ( ← ) arrow button to jump to an existing mark.

2. Push Set/Clear.

If no search mark is at the screen center, the oscilloscope will add one.

3. Investigate your waveform by moving from search mark to search mark. Use the next ( → ) or previous ( ← ) arrow button to jump from one marked location to another, without adjusting any other controls.
4. Delete a mark. Push the next ( → ) or previous ( ← ) arrow button to jump to the mark you want to clear. To remove the current, center-positioned mark, push Set/Clear. It works on both manually and automatically created marks.



To automatically set and clear (delete) search marks:

1. Push **Search**.

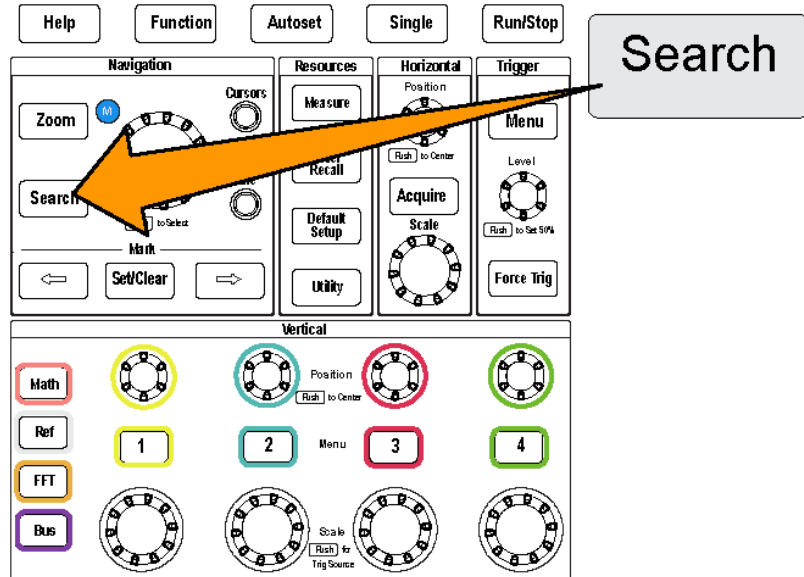

1525-58

2. Push the Search lower side-menu button and select **On**.

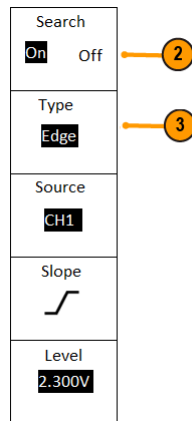

The search menu is similar to the trigger menu.

3. Push **Search Type**.

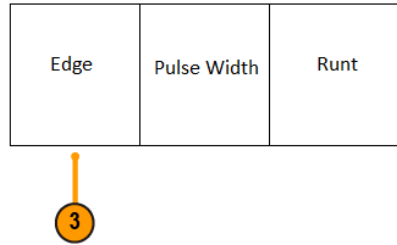

Turn **Multipurpose** knob to select the search type: Edge, Pulse Width, and Runt.

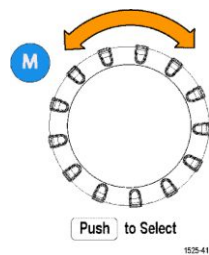

On the screen, hollow triangles show the location of automatic marks and solid triangles show the custom (user-defined) locations. These appear on both normal and zoomed waveform views.

4. You can quickly investigate your waveform by moving from search mark to search mark with the next (→) and previous (←) arrow buttons. No other adjustments are needed.

### Quick tips

- Trigger settings can be copied to search settings for other locations in your acquired waveform that meet the trigger conditions.
- Search settings can be copied to trigger settings.
- Custom (User) marks are saved with the waveform when the waveform is saved and when the setup is saved.
- Automatic search marks are not saved with the waveform when the waveform is saved. However, you can easily recapture them by reusing the search function.
- The search criteria are saved in the saved setup.

The Wave Inspector includes the following search capabilities:

Search	Description
Edge	Searches for edges (rising or falling) with a user-specified threshold level.
Pulse Width	Searches for positive or negative pulse widths that are $>$ , $<$ , $=$ , or $\neq$ a user specified pulse width.
Runt	Searches for positive or negative pulses that cross one amplitude threshold but fail to cross a second threshold before crossing the first again. Search for all runt pulses or only those with a duration $>$ , $<$ , $=$ , or $\neq$ a user specified time.

## How to pan a waveform

While the zoom feature is on, you can use the pan feature to quickly scroll through the waveform. To use pan:

To pan a waveform, turn the **Multipurpose** knob when the side-menu button of **Position** is selected in the Zoom menu.

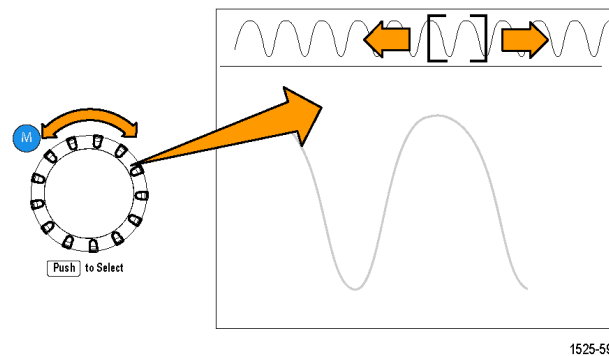

Turn the **Multipurpose** knob clockwise to pan forward. Turn it counterclockwise to pan backwards. The further you turn the knob, the faster the zoom window pans.



---

# Feature enable

## Disable autose in the oscilloscope

For further details refer to [How to enable/disable Autose in the oscilloscope](#) on page 70.

## Disable cursor in the oscilloscope

For further details refer to [How to enable / disable cursor in the oscilloscope](#) on page 107.

## Disable measurement in the oscilloscope

For further details refer to [How to enable / disable measurement in the oscilloscope](#) on page 100.



# Saving data

The oscilloscope has internal memory locations where you can save instrument setups and waveforms. You can also save screen images, setups, and waveforms to files on an external USB drives.

## Saving screen images to a file

Use this procedure to save a screen image to a file on a USB drive. A screen image is a ‘picture’ of the oscilloscope screen. Screen images are useful to include in reports or to compare with other screen images over time.

**NOTE.** A screen image is different than waveform data. A screen image is a picture of the screen, and does not contain any data about the signals shown in the image. Waveform data is a file that contains the numeric values of all the sampled points in a single channel waveform. You cannot use a screen image file for further analysis, whereas you can load the data from a waveform file into other oscilloscopes, or into PC-based analysis programs to perform advanced signal measurements.

1. Install a USB drive.
2. Set up the display to show the waveforms and other readouts that you want to save.
3. Push the **Save/Recall** front-panel button.

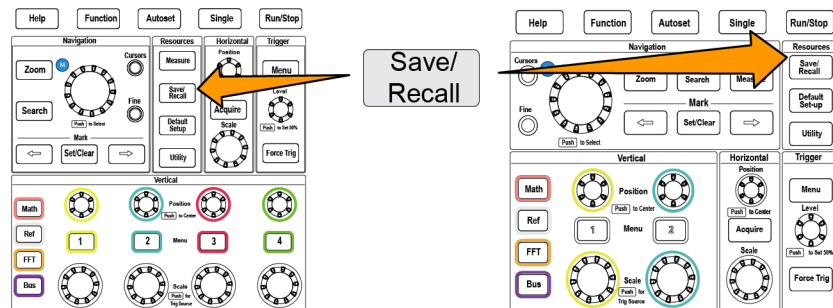

1525-22

4. Push the **Action** side-menu button.
5. Use the **Multipurpose** knob to select and click **Save Image**.
6. Push the **File Format** side-menu button.
7. Select and click a graphical file format (**BMP**, **JPG**, or **PNG**).
8. Push the **Save** side-menu button to save the screen image to an automatically-named file at the top level of the USB drive.

See [About automatically generated file names](#) on page 146.

You can also set the **File Save** button to automatically save an image file to the USB drive. See [Saving files to USB with the Save File button](#) on page 133.

## About saved image file formats

The image save function saves screen information to three common image formats.

- **BMP:** This bitmap format uses a lossless algorithm, and is compatible with most word processing and spreadsheet programs; this is the default. Creates the largest file size.
- **JPG:** This bitmap format uses a lossy compression algorithm, and is compatible with most word processing and spreadsheet programs. Creates the smallest file size.
- **PNG:** This bitmap format uses a lossless compression algorithm, and is compatible with most word processing and spreadsheet programs.

## Saving waveform data

Use this procedure to save waveform data to a reference (**Ref**) memory location or an external file.

1. (Optional) Install a USB drive to save the waveform data to a file on the USB drive.
2. Acquire and display the waveform that you want to save.
3. Push the **Save/Recall** front-panel button.

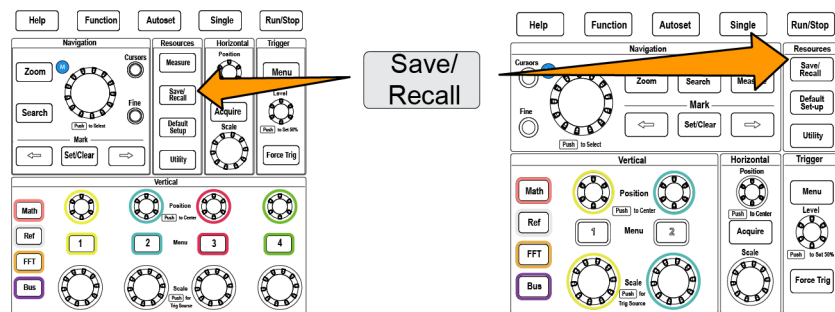

1525-22

4. Push the **Action** side-menu button.
5. Use the **Multipurpose** knob to select and click **Save Waveform**.
6. To save waveform data to internal reference memory:
  - a. Push the **Save To** side-menu button.
  - b. Select and click **Ref**.



- c. Push the **Source** side-menu button
- d. Select and click the waveform data source (**CH1-CH4, Math, FFT**).

---

**NOTE.** *The selected waveform must be displayed on the screen to save waveform data.*

---

- e. Push the **To** side-menu button.
  - f. Select and click **Ref1** or **Ref2**.
  - g. Push the **Save** side-menu button.
7. To save waveform data to a file on the USB drive:
    - a. Push the **Save To** side-menu button.
    - b. Select and click **USB File (\*.ISF)** or **USB File (\*.CSV)**. See [About waveform data files](#) on page 131.
    - c. Push the **Source** side-menu button
    - d. Select and click the waveform data source (**CH1-CH4, Math, FFT, Ref1, Ref2**).

---

**NOTE.** *The selected waveform must be displayed on the screen to save waveform data.*

---

- e. Push the **Save** side-menu button to save the waveform data to an automatically named file on the USB drive. See [About automatically generated file names](#) on page 146.

## About waveform data files

- **.ISF (Internal File Format):** Sets the oscilloscope to save waveform data from analog channels (and math and reference waveforms derived from analog channels), in internal waveform save file (ISF) format. This format is the fastest to write and creates the smallest-sized file. Use this format if you intend to recall a waveform to reference memory for viewing or measuring.
- **.CSV (comma separated values):** Sets the oscilloscope to save waveform data as a comma-separated data file compatible with popular spreadsheet programs. This file cannot be recalled to reference memory. A CSV file is significantly larger than an ISF file, and takes longer to write to the USB drive.
- To find out the channel for which the file was written, open the file in a text editor. The channel name is in the top few lines of the file.

## Saving oscilloscope setup information

You can save the oscilloscope internal settings to an internal memory location (setup 1–10) or to an external file on the USB drive. A setup file contains most of the oscilloscope settings, including vertical, horizontal, trigger, cursor, and measurement parameters. It does not include communications information, such as GPIB addresses. You can then use the setup data to quickly set the oscilloscope to take a certain measurement.

Use this procedure to save the current oscilloscope settings to a memory location or external file.

1. (Optional) Install a USB drive to save the setup data to a file on the USB drive.
2. Push the **Save/Recall** front-panel button.

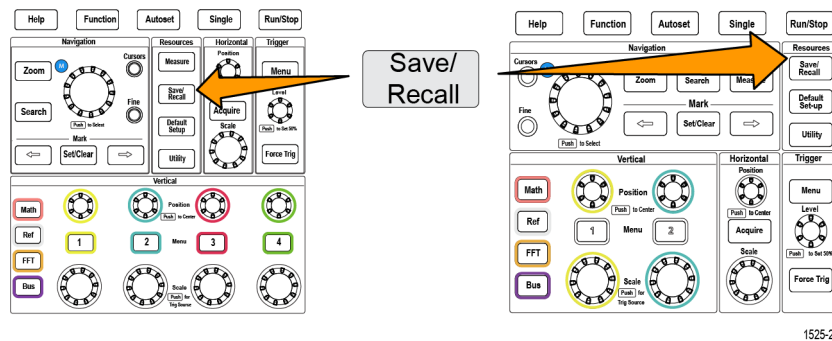

3. Push the **Action** side-menu button.
4. Use the **Multipurpose** knob to select and click **Save Setup**.
5. To save setup data to internal setup memory:
  - a. Push **Save To** side-menu button.
  - b. Select and click **Setup**.
  - c. Push **Setup** side-menu button and use the **Multipurpose** knob to select the setup memory location (1-10).
  - d. Push **Save** side-menu button.
6. To save setup data to a file on the USB drive:
  - a. Push **Save To** side-menu button.
  - b. Use the **Multipurpose** knob to select and click **USB File (\*.SET file)**.
  - c. Push **Save TEKxxxxx.SET** side-menu button to save the setup data to an automatically named \*.SET file at the top level of the USB drive. See [About automatically generated file names](#) on page 146.

## Saving files to USB with the Save File button

The **Save File** button is a quick, one-push way to save a specified data files to the USB drive. After you have defined the save parameters with the **Save/Recall** button and **Action** side-menu button, you can assign that save action to the **Save File** button. For example, if you assign **Save** to write waveform data to a USB drive, then each push of the **Save** button saves the current waveform data to the USB drive.

---

**NOTE.** The **Save** button only saves files to the USB drive. You cannot assign the **Save** button to save information to reference or setup memory, or to recall files from the USB drive.

---

**NOTE.** The oscilloscope saves files to the top level of the USB drive by default. You can use the **Change folder** button in the **File Utility** side menu to set the oscilloscope to save files to a specific location on the USB drive. See [Changing the default file save location on the USB drive](#) on page 141.

---

Files are saved to the USB drive using a specific naming convention. See [About automatically generated file names](#) on page 146.

1. Push the **Save/Recall** front-panel button.

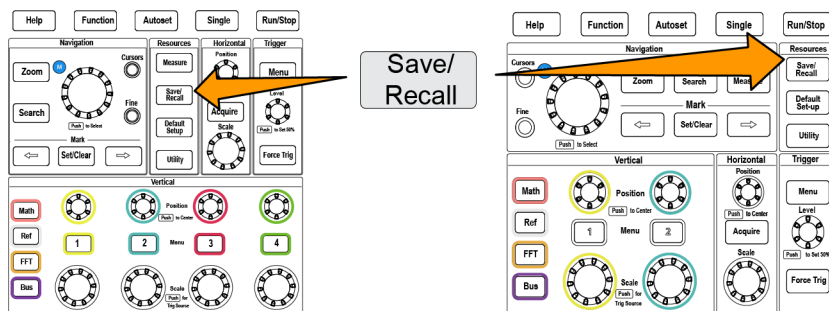

1525-22

2. Push the **Assign To** side-menu button.
3. Push the side-menu buttons for the action that you want to assign to the **Save** button (**Screen Image**, **Waveform**, or **Setup**). The save button is now assigned to that action.
4. For image or setup files: Use the **Save/Rec** side-menu buttons to select the output format for the action you assigned to the Save button (BMP, JPG, or PNG for screen images; .ISF or .CSV for waveforms).

---

**NOTE.** Setup files will always be saved as **.SET** files.

---

5. For waveform files: Use the **Save/Rec** side-menu buttons to select the signal source for saving waveforms (**CH1-CH4, Math, Ref1-2**).
6. Push the **Save** button to confirm that the assigned file type and format was saved to the USB drive.

---

**NOTE.** *The **Assign To** button does not store the current save settings (such as file format or waveform source). The **Save** button uses the settings of the **Save/Rec** side menu to save files.*

---

# Recalling data

The oscilloscope provides permanent internal memory locations from which you can recall instrument setups and waveforms. You can also recall (load) setups and waveforms from files on an external USB drive.

## Recalling oscilloscope setup information

Use this procedure to recall (load) oscilloscope settings from a memory location or external file and set the oscilloscope to those settings.

You can recall (load) saved setup data to quickly configure the oscilloscope to take a certain measurement. A setup file contains most of the oscilloscope settings, including vertical, horizontal, trigger, cursor, and measurement parameters. It does not include communications information, such as GPIB or LAN configuration.

1. (Optional) Install a USB drive to recall the setup data from a file on the USB drive.
2. Push the **Save/Recall** front-panel button.

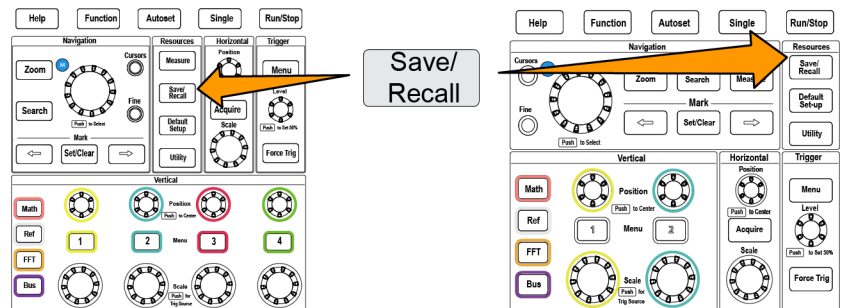

1525-22

3. Push the **Action** side-menu button.
4. Use the **Multipurpose** knob to select and click **Recall Setup**.
5. To recall setup data from internal setup memory:
  - a. Push the **Recall From** side-menu button.
  - b. Select and click **Setup**.

- c. Push the **Setup** side-menu button and use the **Multipurpose** knob to select the setup memory location (1-10).
  - d. Push the **Recall** side-menu button. The oscilloscope changes its settings to those that are in the specified setup memory.
6. To recall (load) setup data from a file on the USB drive:
    - a. Push the **Recall From** side-menu button.
    - b. Select and click **USB File (\*.SET)**.
    - c. Push the **Select File** side-menu button.
    - d. Highlight the setup file (\*.SET) to load.
    - e. Push the **Multipurpose** knob or the **Recall** side-menu button. The oscilloscope loads and implements the settings.

## Recalling waveform data

Use this procedure to recall (load) waveform data from an external .ISF file to load into a reference memory location and display on the oscilloscope. The oscilloscope can only load .ISF waveform data files.

1. Install a USB drive that contains the .ISF waveform data file.
2. Push the **Save/Recall** front-panel button.

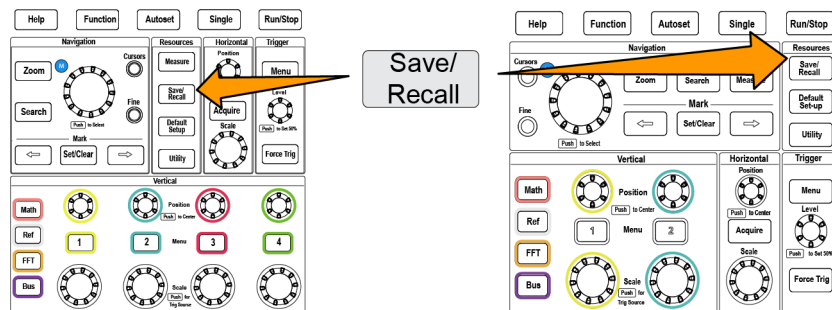

1525-22

3. Push the **Action** side-menu button.
4. Use the **Multipurpose** knob to select and click **Recall Waveform**.
5. Push the **To** side-menu button.
6. Select and click **Ref1** or **Ref2**.
7. Push **Select File** side-menu button to open the File Utility pane.
8. Use the **Multipurpose** knob to select the waveform file (\*.ISF).

9. Push **Recall** side-menu button. The oscilloscope loads the waveform data into the selected reference memory.

---

**NOTE.** *If the **Recall** side-menu button shows **No file**, then you have not selected an .ISF file.*

---





# Using the USB file utility functions

Use the **File Utility** functions to do file-related tasks on a connected USB drive. File tasks include:

- Change the default folder where files are saved. See [Changing the default file save location on the USB drive](#) on page 141.
- Create new folders See [Creating a new folder on the USB drive](#) on page 142.
- Delete files and folders See [Deleting files or folders from the USB drive](#) on page 143.
- Rename files and folders See [Renaming files or folders on the USB drive](#) on page 144.
- Format the USB drive See [Formatting the USB drive](#) on page 145.

## Overview of the File Utility pane

To open the **File Utility** pane, push the **Save/Recall** front-panel button and push the **File Utility** side-menu button.

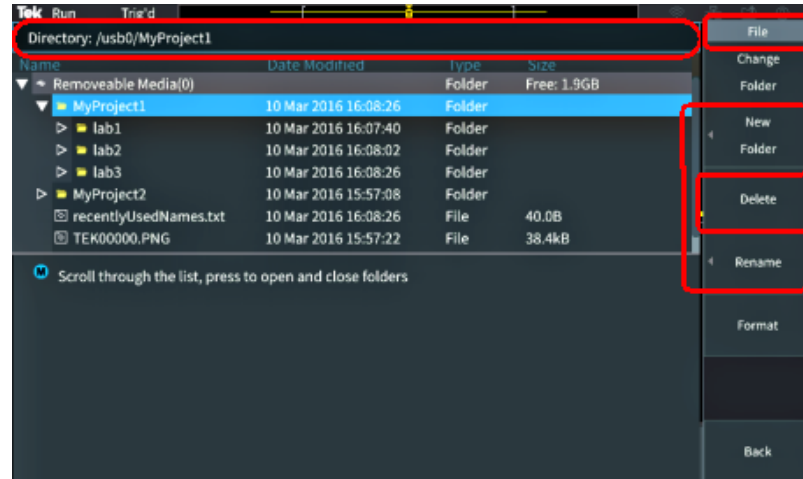

- The **Directory** field lists the path for the highlighted folder or file. This is also the field you use to enter text to create or rename files or folders.
- The area below the Directory field shows the files and folders. Use the **Multipurpose** knob to highlight a name. Push the **Multipurpose** to open or close a folder. Folders are marked with a ► when closed, and with a ▼ when that folder is open.

- The **File** side-menu buttons perform the indicated file utility functions. **Change Folder**, **Delete**, and **Format** directly perform the indicated tasks.
- **New Folder** and **Rename** open the character entry field, keyboard, and side-menu buttons, shown in the following image.

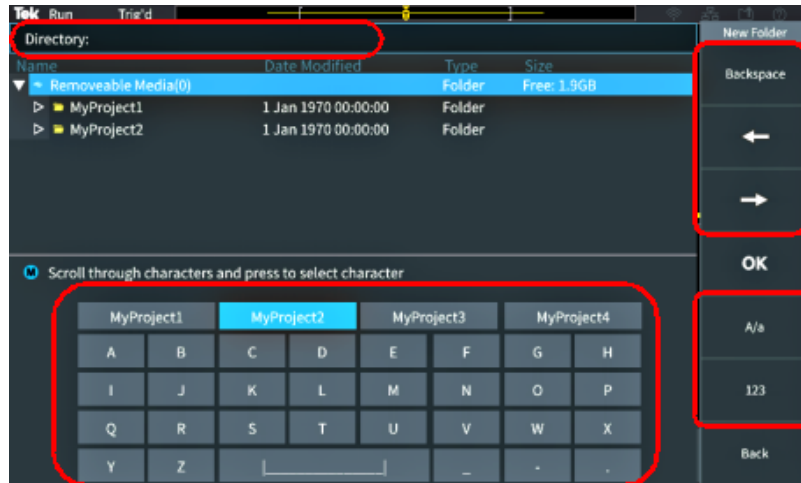

- Use the **Multipurpose** knob to select and click a recently created name (listed at top of the characters list), or highlight the individual letters of the name that you want to enter. Then push the **Multipurpose** knob to add that letter to the **Directory** field. Repeat this process to enter the entire name.

---

**NOTE.** *If you are renaming an image, waveform, or setting file, you do not need to add the extension name when renaming the file.*

---

- Use the upper side-menu buttons to delete the character to the left of the cursor (**Backspace**). or move the cursor left or right in the **Directory** field.
- Use the lower side-menu buttons to show upper-or lower-case letters on the keyboard or show a numeric keypad.
- Push the **OK** side-menu button to create or rename the file or folder with the name in the **Directory** field.

## Changing the default file save location on the USB drive

By default, the oscilloscope saves image, waveform, and setup files to the top directory of the USB drive. Use this procedure to select a different default save folder on the USB drive in which to save files.

1. Push the **Save/Recall** front-panel button.

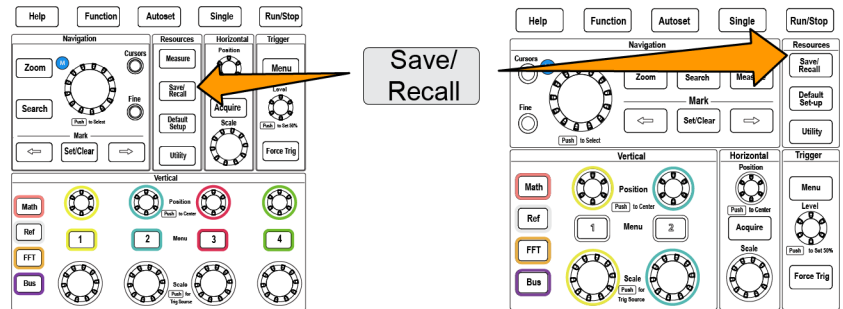

1525-22

2. Push the **File Utility** side-menu button.
3. Use the **Multipurpose** knob to navigate to and highlight a folder in which to save files.
4. Push the **Change Folder** side-menu button. Saved files will now be saved to this location.

## Default save folder location rules

- The new save folder location remains in effect until:
  - A new location is set with the **Change Folder** button.
  - The oscilloscope is powered down. The save location changes back to the top level of the USB drive.
- The following actions do not change the file save location. The oscilloscope shows an error message when it tries to save the file to a location that it cannot find. Use the **Change Folder** function to change the working folder location to an existing folder and try the save operation again.
  - Deleting the save location folder.
  - Removing or inserting a USB drive.
  - Pushing the **Default Setup** front-panel button.

## Creating a new folder on the USB drive

Use this procedure to create a new folder on the USB drive.

1. Push the **Save/Recall** front-panel button.

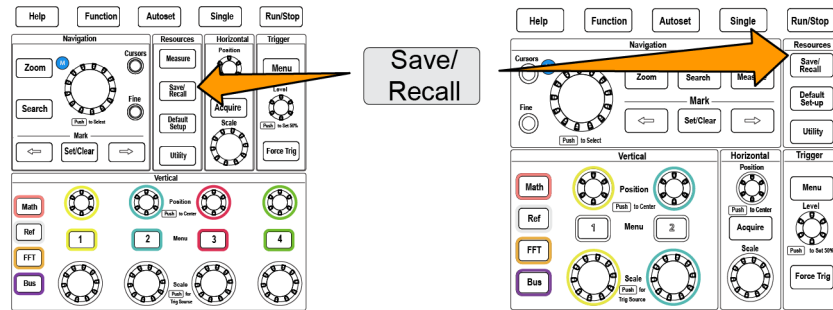

1525-22

2. Push the **File Utility** side-menu button.
3. Use the **Multipurpose** knob to navigate to the location at which to create the new folder.
4. Push the **New Folder** side-menu button.
5. Use the **Multipurpose** knob to select and click a recently created name (listed at top of the characters list), or enter the folder name using the **Multipurpose** knob and side-menu buttons to scroll through and highlight letters, numbers, and valid characters in the list.

Click the **Multipurpose** knob to enter the highlighted character. The characters that you enter are shown at the top of the file pane.

6. Repeat step 5. until you have entered the folder name.
7. Push the **OK** side-menu button to add the new folder name to the USB drive.

---

**NOTE.** There are four names at the top of the character list (default values are MyProject1-4). These names will change to show the most recent file or folder names that you have created. These names change back to the default values when you power off the oscilloscope or push the **Default Setup** front-panel button.

---

## Folder creation tip

If you need to create many folders on a USB drive, it is faster to insert the USB drive into a PC and use the standard Microsoft Windows or other OS folder creation utilities.

## Deleting files or folders from the USB drive

Use this procedure to delete files or folders from the USB drive.

1. Push the **Save/Recall** front-panel button.

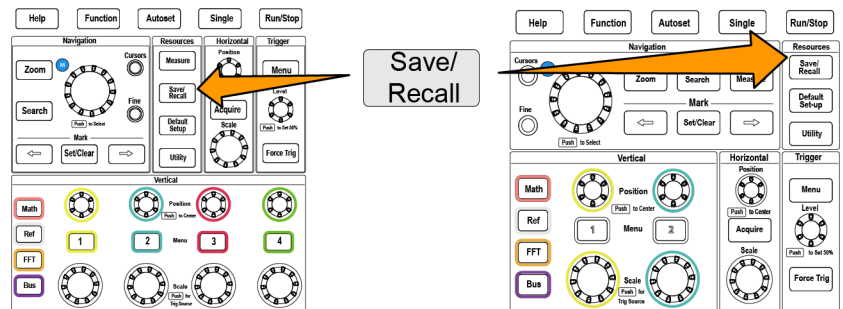

1525-22

2. Push the **File Utility** side-menu button.
3. Use the **Multipurpose** knob to navigate to and highlight a file or folder name to delete.
4. Push the **Delete** side-menu button. the oscilloscope asks you confirm the delete action.
5. Highlight **Yes** (to delete) or **No** (to cancel the delete).
6. Push the **Multipurpose** knob to delete the file or folder.

---

**NOTE.** Deleting a folder also deletes all files and subfolders contained in that folder.

---



**CAUTION.** Deleting a file or folder on the USB drive does not remove the data on the drive. It deletes the FAT table entries for the names of the files and folders and marks the memory as available. If you have critical or secure data that must be removed from the USB drive, connect the USB drive to a PC and use a file 'shredding' program to replace the file data with zeros.

---

## Renaming files or folders on the USB drive

Use this procedure to rename files and folders from the USB drive.

1. Push the **Save/Recall** front-panel button.

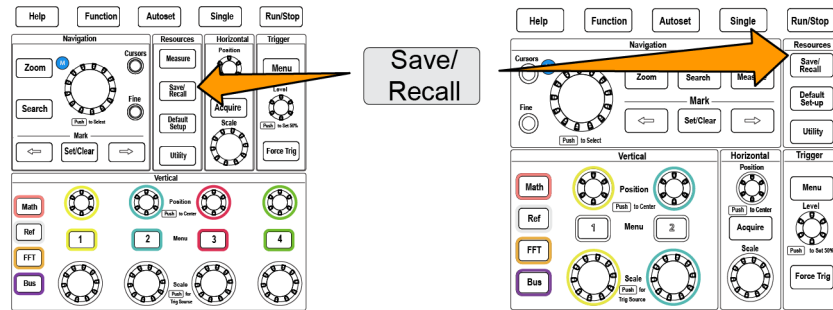

1525-22

2. Push the **File Utility** side-menu button.
3. Use the **Multipurpose** knob to navigate to the location at which to create the new folder.
4. Push the **Rename** side-menu button.
5. Select and click a recently created name (listed at top of the characters list), or enter the folder or file name using the **Multipurpose** knob and side-menu buttons to scroll through and highlight letters, numbers, and valid characters in the list.

Push the **Multipurpose** knob to enter the highlighted character. The characters that you enter are shown at the top of the file pane.

6. Repeat step 5. until you have entered all characters of the folder name.
7. Push the **OK** side-menu button to add the new folder name to the USB drive.

---

**NOTE.** You do not need to add the file extension name (.ISF, .SET, and so on) when renaming an image, waveform, or setting file.

---

## File folder renaming tip

If you need to rename many files or folders, it is faster to insert the USB drive into a PC and use the standard Microsoft Windows or other OS file renaming utilities.

## Formatting the USB drive

Formatting a USB drive removes the file and directory names from the drive, making the entire USB drive memory available for new files and folders.



**CAUTION.** *Formatting a USB drive does not remove the data on the drive. It deletes the FAT table entries for the names of the files and folders and marks the memory as available. If you have critical or secure data that must be removed from the USB drive, connect the USB drive to a PC and use a file 'shredding' program to replace the file data with zeros.*

1. Push the **Save/Recall** front-panel button.

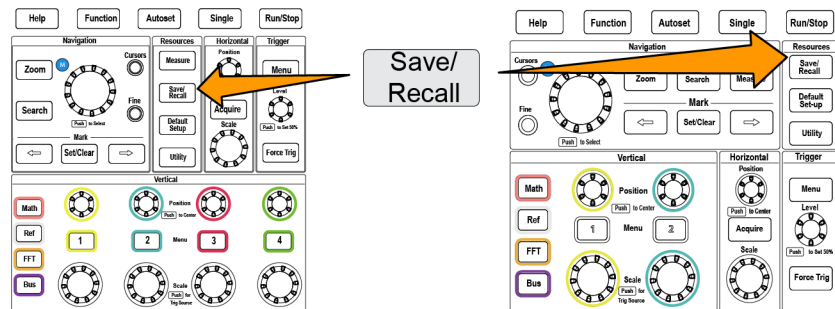

1525-22

2. Push the **File Utility** side-menu button.
3. Push the **Format** side-menu button.
4. Use the **Multipurpose** knob to select and click **Yes**. The oscilloscope formats the drive and reopens the file utility pane.

## About automatically generated file names

The oscilloscope automatically creates a numbered file name for the files that it saves to the USB drive.

The naming convention is TEKXXXXX.<ext>, where:

- XXXXX is an integer from 00000 to 99999
- <ext> is the file type (.PNG, .BMP, or .JPG for screen image files; .SET for setup files; .ISF or .CSV for waveform files)

To create a new file name, the oscilloscope scans the USB drive to determine the highest-numbered file name present for the file type being saved. The oscilloscope then increments that number and uses it for the new file name. For example, the first time you save a file, the oscilloscope creates the file name TEK00000. The next time you save the same type of file, the new file is named TEK00001.

## Image setting and waveform file tips

- If there are nonsequential jumps in the file numbering, such as TEK00001, TEK00002, TEK00005, the oscilloscope uses the highest-numbered file as the starting point for new file names (TEK00006 in this example).
- If you select a different USB drive or folder location, the oscilloscope creates the file number based on the files present in that USB drive or folder. For example, if you select the save folder as /usb0/MyProject1, which contains file TEK00006.png, the next saved .png file in that folder is named TEK00007.png.
- To determine the channel or waveform type (**Math**, **FFT**, **Ref**) of a saved waveform file, open the waveform file (.CSV or .ISF) in a text editor. The channel name or waveform type is at or near the top of the file structure.



# Erasing data from oscilloscope memory (TekSecure)

The TekSecure™ function erases all setup and waveform information saved in the nonvolatile oscilloscope memory. If you have acquired confidential waveform data on your oscilloscope, or use the oscilloscope in a restricted area, use the TekSecure function to erase memory and setup data before you return the oscilloscope to general use.

The TekSecure function:

- Replaces all waveforms in all reference memories with zero (0) values
- Replaces the current front-panel setup and all stored setups with the default setup
- Displays a confirmation or warning message, depending on whether the verification is successful or unsuccessful

## 1. Push **Utility**.

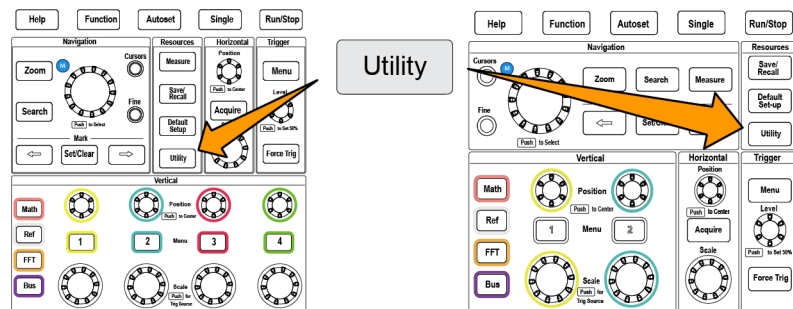

1525-07

2. Push the **Config** side menu.
3. Use the **Multipurpose** knob to select and click **TekSecure Erase Memory**.
4. This procedure will erase all non-volatile RAM. All reference waveforms and saved setups will be erased. Calibration constants will be retained and the system will be rebooted. This will take approximately 5 minutes.
5. Select and click **OK** to start the TekSecure procedure. The erase operation takes up to three minutes.
6. To cancel the procedure, select **No** or push the **Menu Off** button.
7. When the TekSecure procedure is finished, the oscilloscope automatically powers off and then powers back on.



# Setting or viewing USB Device port parameters

Use the USB menu (**Utility > Config > USB**) to select the device that the USB Device port is connected to, disable the USB Device port, and view the USBTMC protocol registration information.

---

**NOTE.** These USB controls do not disable the USB Host ports.

---

## Selecting which device is attached to the USB Device port

Use this procedure to select which device is connected to the **USB Device port**. A supported device does not need to be connected to the **USB Device port** to select that item.

---

**NOTE.** The current software release only supports a PC connection.

---

1. Push **Utility** front-panel button.

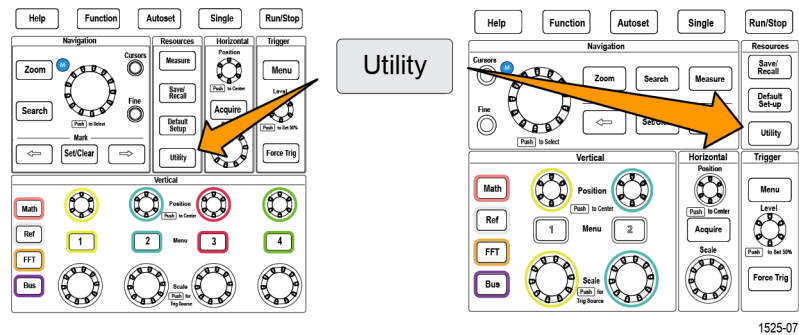

2. Push the **Config** side-menu button. The USB menu item (at top of the **Config** side menu) shows the USB Device port connection status.
3. Use the **Multipurpose** knob to select and click **USB**. The **USB Device Port** menu lists available devices to which you can connect. A grayed out menu item cannot be selected.
4. If the USB Device port is **Disabled (off Bus)**, select and click the device to which you want to connect.

## Disabling the USB Device port

Use this procedure to disconnect the **USB Device port** access, to prevent remote access to the oscilloscope over the USB Device port connection.

**NOTE.** This function only disables the rear-panel **USB Device port**; it does not disable the **USB Host ports** on the front and rear panel.

1. Push **Utility** front-panel button.

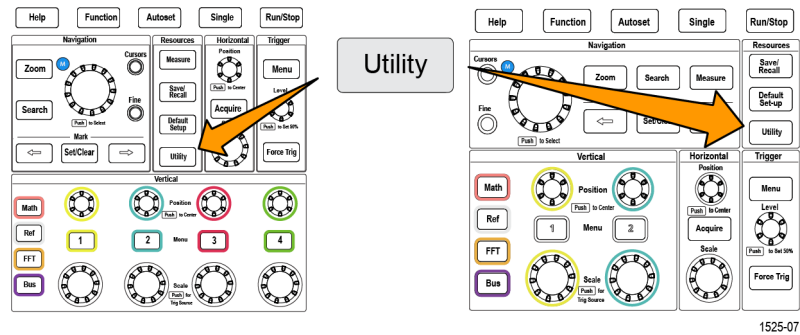

2. Push the **Config** side-menu button.
3. Use the **Multipurpose** knob to select and click **USB**.
4. Select and click **Disabled (Off Bus)**.

## Viewing the USBTMC information

USBTMC stands for USB Test & Measurement Class. USBTMC is a protocol that allows USB devices to communicate using IEEE488 style messages. This protocol lets you run your GPIB software applications on USB hardware. Use this screen to view protocol registration information. There are no active controls on this screen.

1. Push **Utility** front-panel button.

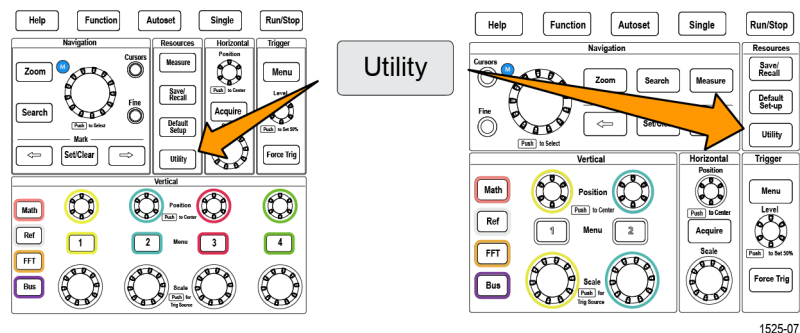

2. Push the **Config** side-menu button.
3. Use the **Multipurpose** knob to select and click **USB**.
4. Select and click **USBTMC Configuration**. The oscilloscope shows the USBTMC protocol registration information.



# Setting up the LAN network

The TBS2000B can connect to a LAN network to provide remote access to the instrument. Handy for classroom work, remotely controlling the oscilloscope, remote monitoring and analysis of waveforms. Use the procedures in this section to connect the oscilloscope to a network using a CAT5 Ethernet cable. A separate section covers configuring the oscilloscope to connect to a Wi-Fi network. See [Setting up the Wi-Fi network](#) on page 157.

## Viewing the IP address - Ethernet

Use this procedure to see the oscilloscope IP address and related network settings. You may need the IP address information to make a connection to the oscilloscope from a PC running on the network.

1. Push **Utility** front-panel button.

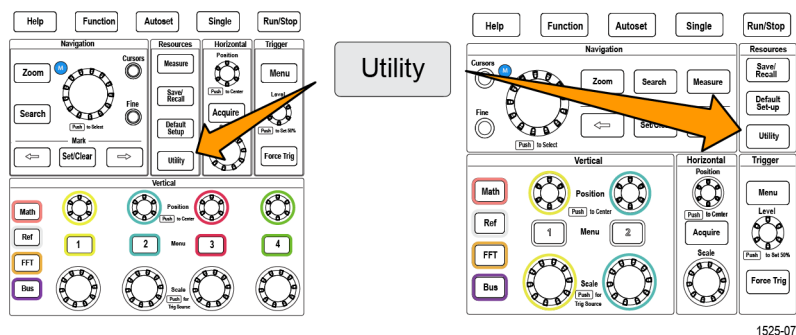

2. Push the **Config** side-menu button.
3. Use the **Multipurpose** knob to select and click **Ethernet Config**.
4. Select and click **LAN Settings**. The oscilloscope shows the IP address and other network-related settings. If no IP address information is shown, and you need to set up the oscilloscope for network access, work with your network administrator to determine how to get an IP address.

## Setting the IP address DHCP network- Ethernet

A Dynamic Host Configuration Protocol (DHCP) network automatically allocates network IP addresses and settings to DHCP-enabled instruments like the TBS2000B Series oscilloscope. Use this procedure to turn DHCP-capability on and enable the oscilloscope to obtain an IP address from the network DHCP server.

**NOTE.** DHCP-generated IP addresses can change each time the oscilloscope is powered on and requests an IP address from the DHCP server. If the oscilloscope needs a permanent unchanging IP address, contact your system administrator to obtain a permanent IP address and then add it manually to the oscilloscope.

Prerequisite: The oscilloscope must be connected to a DHCP-enabled network.

1. Push **Utility** front-panel button.

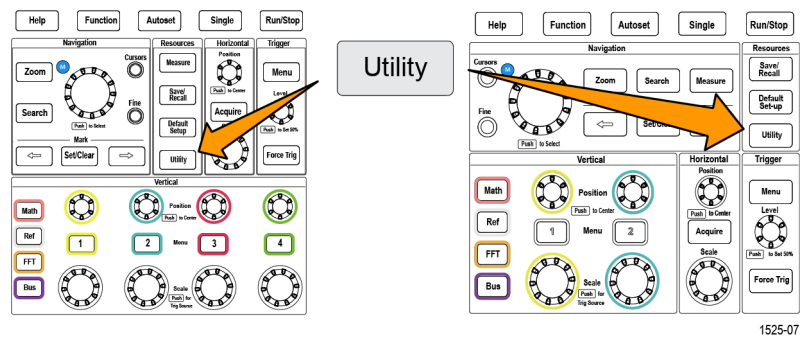

2. Push the **Config** side-menu button.
3. Use the **Multipurpose** knob to select and click **Ethernet Config**.
4. Highlight **DHCP**.
5. Push the **Multipurpose** knob to select **ON**. The oscilloscope takes a few moments to request and load the IP address from the DHCP server. The LAN Test menu items should now show **OK**, and the network connection icon (upper right edge of screen) should be on (white).
6. You can find out the IP address that was loaded into the oscilloscope. See [Viewing the IP address - Ethernet](#) on page 153.



## Setting the IP address nonDHCP network- Ethernet

If your network does not have Dynamic Host Configuration Protocol (DHCP) to automatically assign an IP address to the oscilloscope, you must manually enter IP address and other network settings so that your oscilloscope can connect to a network. Use this procedure to enter IP address and other network settings.

Prerequisite: Obtain the correct network settings from your system administrator (IP address, Subnet Mask, Default Gateway, DNS IP address, and HTTP Port).

1. Push **Utility** front-panel button.

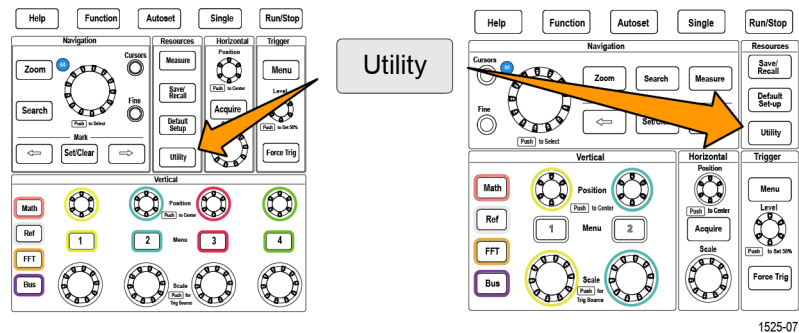

2. Push the **Config** side-menu button.
3. Use the **Multipurpose** knob to select and click **Ethernet Config**.
4. Select and click **IP Addresses Settings**. The oscilloscope opens the IP Addresses Settings dialog box.
5. Use the **Multipurpose** knob and side-menu buttons to enter the required network settings.
6. Push the **OK** side-menu button to enter the settings in the oscilloscope.
7. Confirm that the IP address was loaded into the oscilloscope. See [Viewing the IP address - Ethernet](#) on page 153.
8. Select and click the **LAN Test** menu item. The LAN Test menu should now show **OK**, and the network connection icon (upper right edge of screen) should be on (white).

---

**NOTE.** If the LAN Test menu item shows **No Response**, work with your system administrator to confirm that the settings that you were given are correct. Check that you entered the settings correctly.

---

## Turning Ethernet DHCP on or off

A Dynamic Host Configuration Protocol (DHCP) network automatically allocates network IP addresses and settings to DHCP-enabled instruments like the TBS2000B Series oscilloscope. Use this procedure to turn the oscilloscope DHCP-capability on or off.

1. Push **Utility** front-panel button.

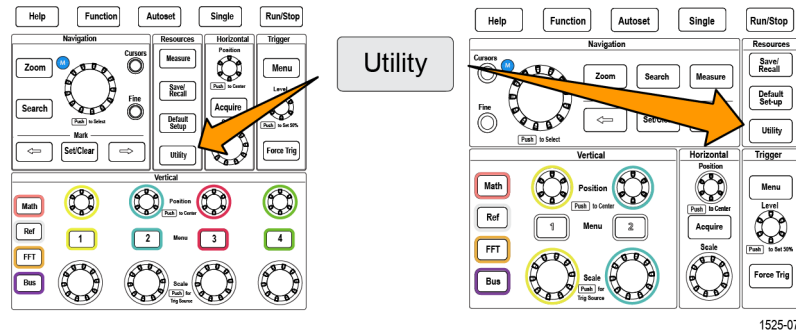

2. Push the **Config** side-menu button.
3. Use the **Multipurpose** knob to select and click **Ethernet Config**.
4. Highlight **DHCP**.
5. Push the **Multipurpose** knob to select **ON**. The oscilloscope takes a few moments to request and load the IP address form the DHCP server. The LAN Test menu items should now show **OK**, and the network connection icon (upper right edge of screen) should be on (white).
6. Push the knob again to turn DHCP **Off**.

# Setting up the Wi-Fi network

Connecting a Wi-Fi transceiver (dongle) to the rear USB Host port on your oscilloscope enables you to connect the instrument to a Wi-Fi network. You can then use the Wi-Fi connection to access the oscilloscope from mobile devices such as a smart phone or tablet, or from a PC.

This section covers configuring the oscilloscope to connect to a Wi-Fi network. A separate section covers configuring the oscilloscope to connect to a network using a CAT5 Ethernet cable. See [Setting up the LAN network](#) on page 153.

## Turning Wi-Fi on or off

You must turn on the Wi-Fi function before you can communicate with the oscilloscope. Use this procedure to turn on or off Wi-Fi.

Prerequisites:

- Connect a supported Wi-Fi dongle to the rear USB Host port (Tektronix option TEKUSBWIFI). Recommendation is to use the rear USB port so that you keep the front USB port available for saving and loading files.
- DHCP connectivity is **On**.

1. Push the **Utility** front-panel button.

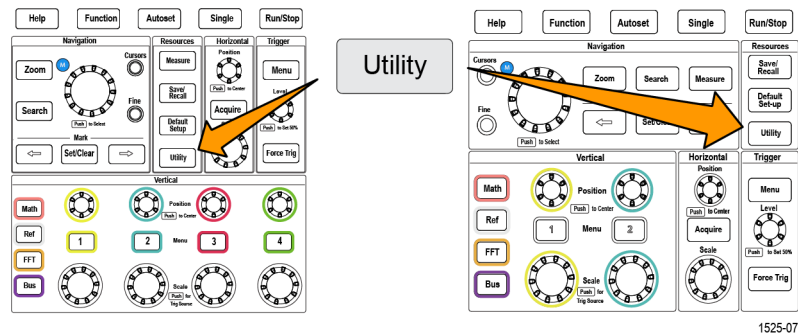

2. Push the **Config** side-menu button.
3. Use the **Multipurpose** knob to select and click **Wi-Fi Config**.
4. Highlight **Wi-Fi On Off**.
5. Push the **Multipurpose** knob to select **ON**. The oscilloscope takes a few moments to make the connection and request and load the IP address from the network server. The Wi-Fi network connection icon (upper right edge of screen) should be on (white).
6. Push the knob again to turn Wi-Fi to **Off**.

## Viewing Wi-Fi settings

Use this procedure to show the oscilloscope Wi-Fi settings.

Prerequisite: A Wi-Fi dongle is connected to the oscilloscope and Wi-Fi is turned on. See [Turning Wi-Fi on or off](#) on page 157.

1. Push the **Utility** front-panel button.

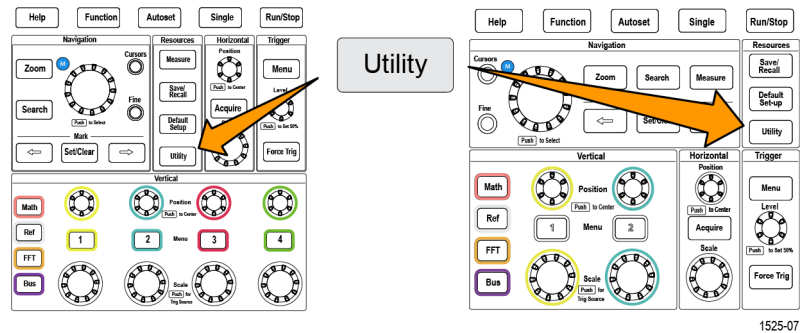

2. Push the **Config** side-menu button.
3. Use the **Multipurpose** knob to select and click **Wi-Fi Config**.
4. Select and click **Wi-Fi Settings**. The oscilloscope shows the IP address information and the Wi-Fi SSID and connection signal level information.

## Viewing and selecting available Wi-Fi networks

Use this procedure to see the Wi-Fi networks the oscilloscope can detect, and select the Wi-Fi network to use for communication.

Prerequisite: A Wi-Fi dongle is connected to the oscilloscope and Wi-Fi is turned on. See [Turning Wi-Fi on or off](#) on page 157.

1. Push the **Utility** front-panel button.

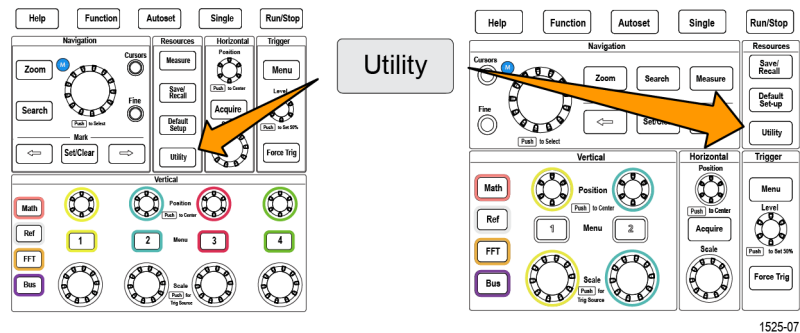

2. Push the **Config** side-menu button.

3. Use the **Multipurpose** knob to select and click **Wi-Fi Config**.
4. Select and click **Available Networks**. The oscilloscope shows the networks and signal strengths of all the detected Wi-Fi networks.
5. Select and click the Wi-Fi network to use for communication. A check mark in the network menu means that is the selected network for communication.

## Setting the IP address (nonDHCP) network in Wi-Fi

If your network does not have Dynamic Host Configuration Protocol (DHCP) to automatically assign an IP address to the oscilloscope, you must manually enter IP address and other network settings so that your oscilloscope can connect to a network. Use this procedure to enter IP address and other network settings.

Prerequisites: Obtain the correct network settings from your system administrator (IP address, Subnet Mask, Default Gateway, DNS IP address, and HTTP Port).

1. Push **Utility** front-panel button.
2. Push the **Config** side-menu button.
3. Use the **Multipurpose knob** to select and click **Ethernet Config**.
4. Select and click **IP Addresses Settings**. The oscilloscope opens the IP Addresses Settings dialog box.
5. Use the **Multipurpose knob** and side-menu buttons to enter the required network settings.
6. Push the **OK** side-menu button to enter the settings in the oscilloscope.
7. Confirm that the IP address was loaded into the oscilloscope. (See [Viewing the IP address - Ethernet](#) on page 153.)

You can view the LAN Test menu item. The LAN Test menu should now show **OK**, and the network connection icon (upper right edge of screen) should be on (white).

---

**NOTE.** *If the LAN Test menu item shows **No Response**, work with your system administrator to confirm that the settings that you were given are correct. Check that you entered the settings correctly.*

---

## Setting the IP address DHCP network in Wi-Fi

A Dynamic Host Configuration Protocol (DHCP) network automatically allocates network IP addresses and settings to DHCP-enabled instruments like the TBS2000B Series oscilloscope. Use this procedure to turn DHCP-capability on and enable the oscilloscope to obtain an IP address from the network DHCP server.

---

**NOTE.** *DHCP-generated IP addresses can change each time the oscilloscope is powered on and requests an IP address from the DHCP server. If the oscilloscope needs a permanent unchanging IP address, contact your system administrator to obtain a permanent IP address and then add it manually to the oscilloscope*

---

Prerequisites:

- A supported Wi-Fi dongle is connected to the oscilloscope and Wi-Fi is turned on. (*Turning Wi-Fi on or off* on page 157 .)
  - The oscilloscope must be connected to a DHCP-enabled network.
1. Push **Utility** front-panel button.
  2. Push the **Config** side-menu button.
  3. Use the **Multipurpose knob** to select and click **Wi-Fi Config**.
  4. Highlight DHCP.
  5. Push the **Multipurpose knob** to select **ON**. The oscilloscope takes a few moments to request and load the IP address from the DHCP server. The LAN Test menu items should now show **OK**, and the network connection icon (upper right edge of screen) should be on (white).
  6. You can find out the IP address that was loaded into the oscilloscope. (See *Viewing the IP address - Ethernet* on page 153.)

## Turning DHCP on or off Wi-Fi

A Dynamic Host Configuration Protocol (DHCP) network automatically allocates network IP addresses and settings to DHCP-enabled instruments like the TBS2000B Series oscilloscope. Use this procedure to turn the oscilloscope DHCP-capability on or off.

Prerequisites:

- A supported Wi-Fi dongle is connected to the oscilloscope and is turned on. See [Turning Wi-Fi on or off](#) on page 157.
- The network to which you are connecting must be DHCP-enabled.

1. Push **Utility** front-panel button.

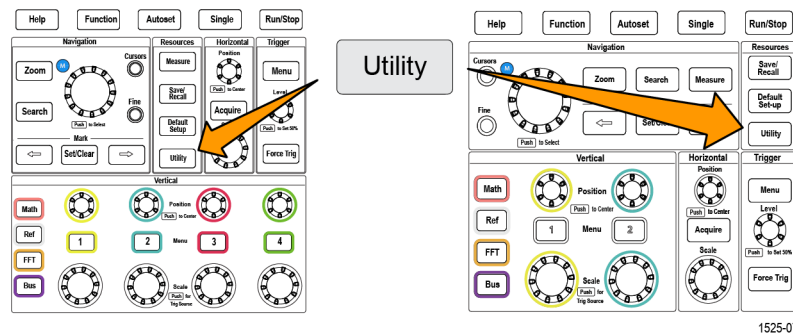

1525-07

2. Push the **Config** side-menu button.
3. Use the **Multipurpose** knob to select and click **Wi-Fi Config**.
4. Highlight **DHCP**.
5. Push the **Multipurpose** knob to select **ON**. The oscilloscope takes a few moments to request and load the IP address form the DHCP server. The LAN Test menu items should now show **OK**, and the network connection icon (upper right edge of screen) should be on (white).
6. Push the knob again to turn DHCP **Off**.





# Connecting your oscilloscope to a computer

Connect your oscilloscope directly to a computer to let the PC analyze your data, collect screen images, or control your oscilloscope. There are two ways to connect your oscilloscope to a computer:

- VISA drivers. Use VISA to communicate with your oscilloscope from your computer through a software application, such as Tektronix OpenChoice Desktop®.
- Socket server. Use a socket server to let your oscilloscope communicate with a remote-terminal device or computer.

## Using a socket server

A socket server provides two-way communication over an Internet Protocol-based computer network. By default the socket server is enabled in the TBS2000B Series oscilloscope.

Perform the following steps to set up and use a socket server between your oscilloscope and a remote terminal or computer:

1. Obtain the LAN address of the oscilloscope:
  - a. Push the **Utility** front-panel button.

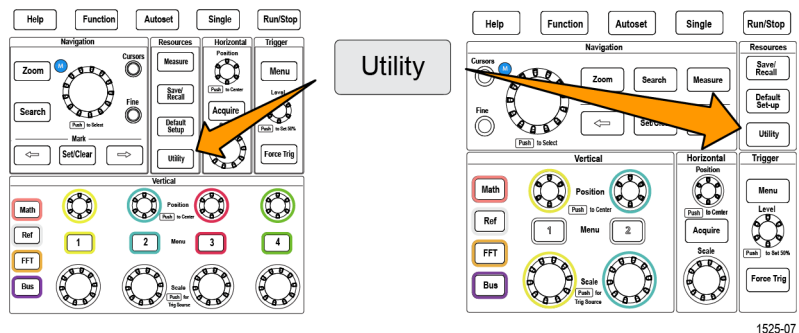

- b. Push the **Config** side-menu button.
- c. Use the **Multipurpose** knob to select and click **Ethernet Config**.
- d. Select and click **LAN Settings**. The oscilloscope shows the IP address and other network-related settings. Make a note of the IP address and the HTTP port number.

---

**NOTE.** If no IP address information is shown, and you need to set up the oscilloscope for network access, work with your network administrator to determine how to get an IP address.

---

2. If you are running a MS Windows PC, open a Telnet client.

---

**NOTE.** *On MS Windows 7, you must first enable Telnet in order for Telnet to work.*

---

3. Start a terminal session between your computer and your oscilloscope by typing in an open command with the oscilloscope's LAN address and port number.

For example, if the oscilloscope IP address was 123.45.67.89 and the port number was the default value of 4000, you could open a session by writing into the MS Windows Telnet screen: **o 123.45.67.89 4000**. The oscilloscope will send a help screen to the computer when it has finished connecting.

4. You can now type in a standard query, such as, \*idn?. The Telnet session window will respond by displaying a character string describing your instrument. You can type in more queries and view more results using this Telnet session window. You can find the syntax for relevant commands, queries and related status codes in the Programmer Manual that is available at the Tektronix website.

---

**NOTE.** *Do not use the backspace key on the computer during an MS Windows Telnet session with the oscilloscope.*

---

---

# Appendices

## Remotely controlling the oscilloscope from a Web browser e\*Scope

The oscilloscope has a built-in e\*Scope interface. The Web browser shows instrument status, configuration, and controls with which to remotely control the oscilloscope and view waveforms. You can connect to the oscilloscope Web page by simply entering the oscilloscope's IP address in the address bar of a Web browser.

Prerequisites:

The oscilloscope is connected to a network (LAN or Wi-Fi).

The oscilloscope has an assigned IP address.

See [Setting up the LAN network](#) on page 153. See [Setting up the Wi-Fi network](#) on page 157.

1. Open a Web browser on the PC.
2. Enter the oscilloscope IP address on the URL line of the browser. For example: HTTP://135.62.88.157.
3. The browser searches for and opens the TBS2000B Welcome Web page for the oscilloscope.

---

**NOTE.** *If the PC browser does not display the oscilloscope browser page, verify that the oscilloscope is connected and communicating with the local network to which the PC has access, and that the IP address that you entered in the PC browser is correct.*

---

4. Use the mouse and cursor to select browser tabs and interact with the available oscilloscope controls. You can use the mouse to select and open menus and submenus. Use the keyboard to enter numeric values where required.

---

**NOTE.** *Search mark feature is not available on the e\*Scope.*

---

## Installing new firmware on the oscilloscope

Tektronix releases new oscilloscope firmware to improve existing functions or add new functions. Complete the following steps to install new firmware in the oscilloscope.

1. Go to <http://tek.com>.
2. Click **Downloads**. In the Downloads menu, select DOWNLOAD TYPE as Software and enter TBS2000B in the MODEL OR KEYBOARD field and click **SEARCH**.
3. Select the latest version of the software and follow the instructions to download. Download the latest firmware for your oscilloscope on your PC.
4. Unzip the files and copy the TBS2000B.TEK file into the root folder of a USB flash drive.
5. Power on the oscilloscope.
6. Insert the USB flash drive into the front-panel USB port on your oscilloscope.
7. Push the **Utility** button.

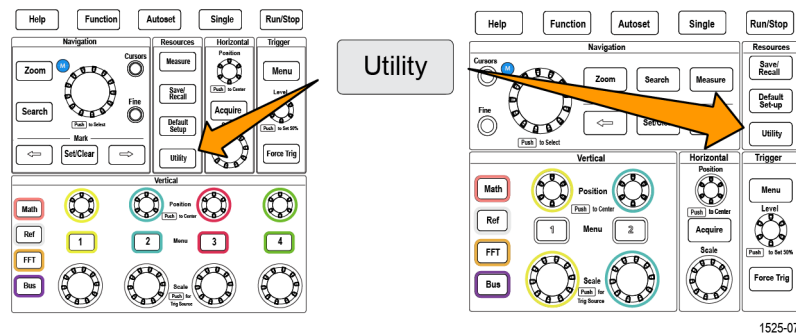

8. Push the **Update Firmware** side-menu button. Screen shows **Update Firmware** message.
9. Turn the **Multipurpose** knob to select **Yes**, then click the **Multipurpose** knob to install the firmware.
10. Follow the on-screen instructions.

---

**NOTE.** Do not power off the oscilloscope or remove the USB flash drive until the oscilloscope finishes installing the firmware. It displays a message saying it is OK to turn off the oscilloscope.

---

11. When the firmware install is finished, power off the oscilloscope, remove the USB drive, and power on the oscilloscope. Let the oscilloscope power-up to the oscilloscope screen.

12. To confirm the firmware installation:
  - a. Push the **Utility** button.
  - b. Push the **Config** side-menu button.
  - c. Use the **Multipurpose** knob to select and click **System Status** to open the System Status message screen.
  - d. Check that the software version number shown on the screen is the same version that you just installed.
13. Select **Utility > More > Calibration > Signal Path** and perform signal path compensation once the oscilloscope is booted after firmware upgrade.

## Running diagnostic tests

Use this procedure to test instrument functional modules.

---

**NOTE.** Running self test, resets the oscilloscope settings. Save the current setup to memory or a file, if you do not want to lose the current settings.

---



---

**NOTE.** Remove all probes and cables from the oscilloscope inputs.

---

1. Push the **Utility** button.

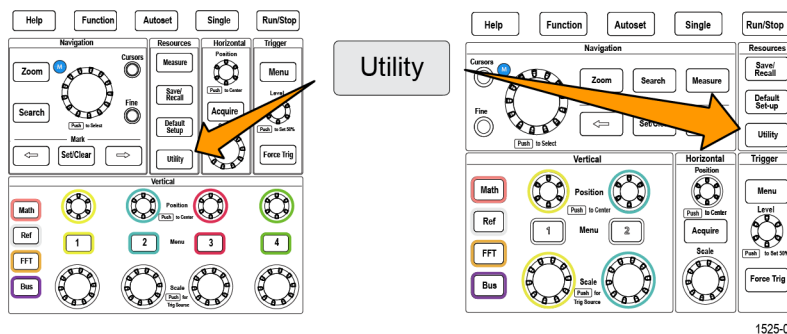

1525-07

2. Push the **-More- Page 1/2** side-menu button.
3. Push the **Diagnostics** side-menu button.
4. Push the **Self Test** side-menu button to display the **Self Test** menu and **Self Test Results** readout.

5. Turn the **Multipurpose** knob to select **Run Self Test**, then click the **Multipurpose** knob to start testing using the default settings. the self test takes a few seconds to run.
6. Use the other **Self Test** menu items to refine how to run the self test; you can run the tests a specified number of times (**Loop Times**), run tests forever (**Loop Forever**), run tests until a test fails and stop testing (**Loop Until Fail**), or run a test on a failed tests (**Loop On Failure**).

---

**NOTE.** *The oscilloscope resets to the factory default settings after running the self tests.*

---

## Courseware on-instrument education and training

Run guided lab exercises right on your oscilloscope. Read overview theory and procedures, and capture your lab results right there as well.

Create new course materials on a PC with separate PC-based Courseware software, which you can download from [www.tek.com/software](http://www.tek.com/software). After you create the course materials, you can distribute them to supported oscilloscopes using a USB drive or from the TekSmartLab software server.

---

**NOTE.** *TekSmartLab uses wireless connectivity to connect multiple oscilloscopes and other test bench instruments to a central server and software interface. Using The TBS2000B series oscilloscope with TekSmartLab requires either a Wi-Fi Transceiver USB dongle (Option TEKUSBWIFI) or a communication box to connect to the TekSmartLab server. See the **Scope Intro** topic on TekSmartLab for more information (**Help ► Scope Intro ► TekSmartLab**).*

---

You can also go to the Courseware Web page at [www.tek.com/courseware](http://www.tek.com/courseware) to download courseware files that others have created and uploaded to share.

---

**NOTE.** *Courseware files are compressed using .zip format. Unzip the Courseware file and copy the uncompressed files to a USB drive.*

---

### Courseware file content information

- A Courseware file can contain up to 12 courses, with up to 100 MB total of course file storage available on the oscilloscope.
- Each course can have up to 14 labs, with each lab having overview and procedure files.
- Courses can contain example waveforms, data results, and waveform masks for student reference use.
- Refer to the Courseware and TekSmartLab documentation for more information on these applications. You can download electronic versions of these manuals from the Tektronix Web site ([www.tek.com](http://www.tek.com)).

### Loading a courseware file from a USB drive

Use this procedure to load a Courseware file. A Courseware file can have up to 12 courses. Each course can contain up to 14 labs.

1. Insert the USB drive that contains the course folder into the front-panel USB connector.
2. Push the **Utility** button.

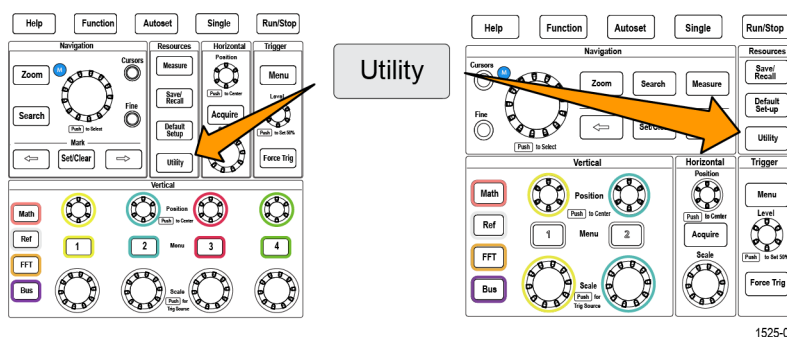

3. Push the **Update Course** side-menu button.
4. Use the **Multipurpose** knob to scroll through the file list and open the course folder to load. Folder and file names are shown in the **Directory** field at the top of the screen as you highlight each one.
5. Look for and highlight the **folder** that contains the file with the .workspace extension.
6. Push the **Change Folder** side-menu button to temporarily change the working folder to this location for reading the courseware files. The selected folder is highlighted in the list.
7. Push the **Upload Course** side-menu button to load the course into your oscilloscope. The oscilloscope displays a brief message saying that the file loaded successfully.

**Dealing with error message**

If you get the “No course material package files found” error message, make sure that you selected the folder that *contains* the .workspace file, and not the .workspace file itself, or any other folders that may be in the Courseware folder.

In the following image, the .workspace file (colored blue) is part of the ST\_AFG\_EN\_MathAddition\_PKG folder (green boxes), so you would highlight ST\_AFG\_EN\_MathAddition\_PKG to load this course. The Package\_RSZI folder (red box) is a subfolder of ST\_AFG\_EN\_MathAddition\_PKG.

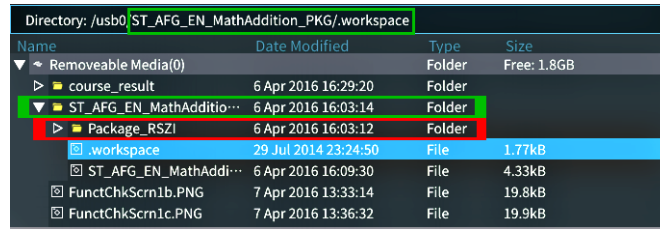

If you still get a load error message, try downloading the courseware file again and reload it.

**Running Courseware lab exercises**

You can access the lab content by pushing the **Course** button located on the on the front panel. Use the oscilloscope’s soft keys and the **Multipurpose** knob to access up to 12 courses, which can have up to 14 labs each.

Once you choose a lab, you can review the overview section, perform the lab using the step-by-step procedure, collect data, check and save the data results, and generate reports that show the waveforms created for each step.

Prerequisite: You have loaded a course on the oscilloscope.

1. Push the **Help** front-panel button.

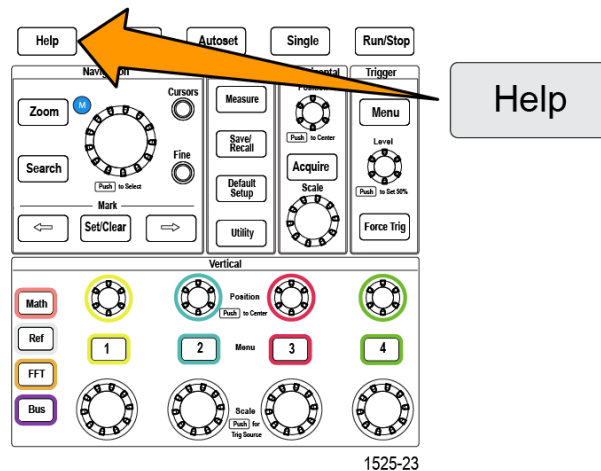



2. Push a side-menu button to select a course from those listed. The main screen area lists the labs that are available for that course.
3. Turn the **Multipurpose** knob to select and click the lab to run (if there is more than one lab).
4. Push the **Overview** side-menu button to read a high-level description of what this lab will teach you.
5. Push the **Procedure** side-menu button. Follow the instructions in the procedure:
  - If a step says to compare your results, push the **Data Collection** side-menu button, push the **Step** side-menu button, use the **Multipurpose** knob to select the step number, and push the **Show Reference** side-menu button to **On**. The oscilloscope shows the reference material associated with that step.
  - If a step says to show a waveform mask, push the **Data Collection** side-menu button, push the **Step** side-menu button, use the **Multipurpose** knob to select the step number, and push the **WFM Mask** side-menu button to **On**. The oscilloscope shows a reference waveform mask and a readout that counts the number of waveform mask errors (pass= the waveform is within the waveform mask area; Fail = part or all of the waveform is out of the mask area).
  - If a step says to save a result, push the **Data Collection** side-menu button, push the **Step** side-menu button, use the **Multipurpose** knob to select the step number, push the **Data Type** side-menu button, and select the type of data to save (Measure(ment), screen Image, or waveform CSV). Then push the **Save Result** side-menu button. The oscilloscope saves the result to temporary memory.

---

**NOTE.** Results that you collect while running a lab are stored in temporary memory on the oscilloscope. Results are not saved permanently until you save a report to the USB drive. Make sure to save results to a report

---

6. Save lab results to a report file on the USB drive. See [Saving Courseware lab results](#) on page 172.

**Saving Courseware lab results**

Use this procedure to save your results to a report when you are done running Courseware courses and labs.

1. Push the **Report** side-menu button. Use the resulting side-menu buttons and the **Multipurpose** knob to enter a report identifier name.
2. Push the **OK** side-menu button. The oscilloscope creates and shows the report on the screen. If the report has any errors or is missing information, push the **Back** side-menu button and redo the step or steps that are missing information, and rerun the **Report** procedure.
3. If the report is OK, push the **Save** side-menu button. The oscilloscope saves the report to the USB drive.
4. To confirm the report was written, push **Save/Recall** side-menu button, push File Utility side-menu button, search for and open the course\_result folder, search for and open the folder for the active course, search for and open the folder of the lab name, and verify that there is a file called report.html.

**The oscilloscope controls**

The front panel has menu buttons and control knobs for the functions that you use most often. The following sections provide a high-level description of the controls and what they do. Use the text links within these sections to go to sections that contain more information about that control.

**The Navigation controls**

The buttons or knobs control waveforms, cursors, and other data input.

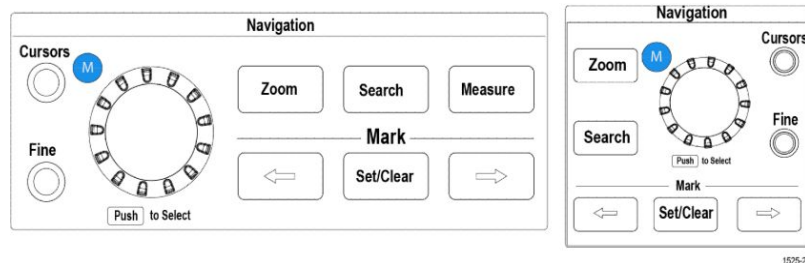

**Figure 3: Navigation on 2 and 4 channel on TBS2000B**

- The **Multipurpose** knob lets you select and click menu or other choices, to move a cursor, and to set a numerical parameter values for a menu item.

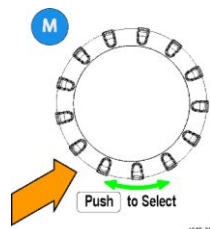

A **M** icon on a menu, message, or dialog box means to use the **Multipurpose** knob to interact with that item.

The arrow symbol below the knob will also light up when you can use the knob to control screen objects or interact with menu items.

Turn the knob to highlight a menu item or control a screen object (such as a cursor, or when entering file name characters).

Push the knob to select or enter a highlighted menu item, switch between cursors, or activate a menu field to enable entering values.

- The **Cursors** button toggles on and off displaying cursors on the screen.

Turn the **Multipurpose** knob to change the position of the active cursor (solid line). Push the **Multipurpose** knob to change the active cursor.

See *Using cursors to take manual measurements* on page 103.

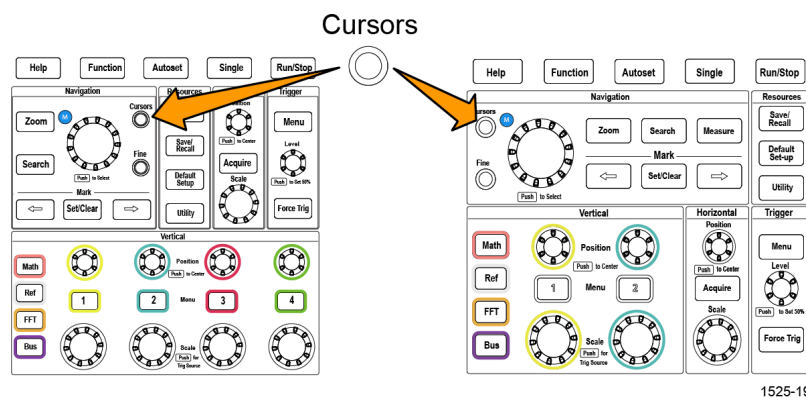

- The **Fine** button enables making fine adjustments with the **Multipurpose** knob, vertical and horizontal **Position** knobs, vertical **Scale** knob, and the trigger **Level** knob.

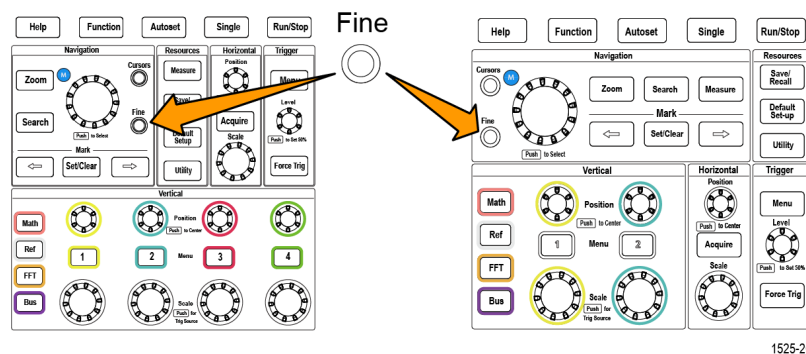

- The **Zoom** button displays a magnified waveform. See *How to view long record length waveforms Zoom* on page 121.

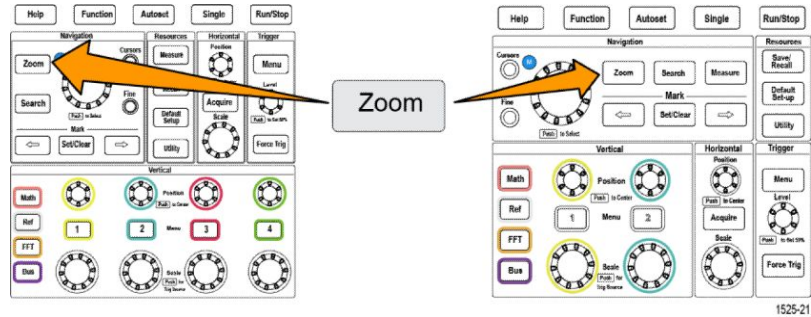

- The **Search** and **Mark** buttons (← (Previous), → (Next), and **Set/Clear**), and the **Multipurpose** knob, let you add marks (tags) to points on a signal of interest waveform, and quickly jump to those marks. This is very useful when examining long record length waveforms.

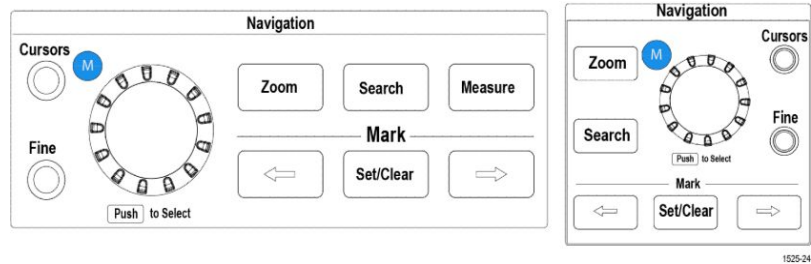
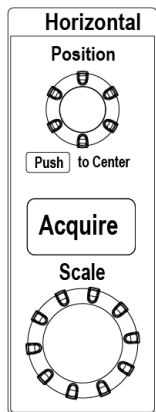

Figure 4: Navigation on 2 and 4 channel on TBS2000B

### The Horizontal controls

The **Horizontal Position** knob adjusts the trigger point location left or right relative to the acquired waveform record.



1525-26

Push the **Position** knob to return the trigger point to the center of the screen (center vertical graticule).

---

**NOTE.** You can push the **Fine** button (*Navigation controls*) to enable smaller adjustments with the position knob.

---

The **Acquire** button opens the menu that you use to set the acquisition mode and adjust the record length.

## The Trigger controls

The Trigger controls set when the oscilloscope starts acquiring signal data to create a waveform record. See *Trigger concepts* on page 40. See *Trigger setup* on page 59.

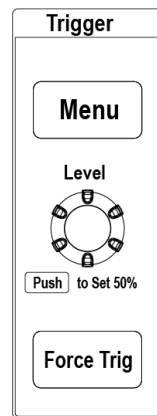

1525-25

The Trigger **Menu** button opens the side menu for trigger settings.

The **Trigger Level** knob adjusts the trigger level. Trigger level is shown with a horizontal line when using this control.

Push the **Trigger Level** knob to set the trigger level to 50% (the vertical midpoint of the waveform).

The **Force Trig** button forces an immediate trigger event.

## The Vertical controls

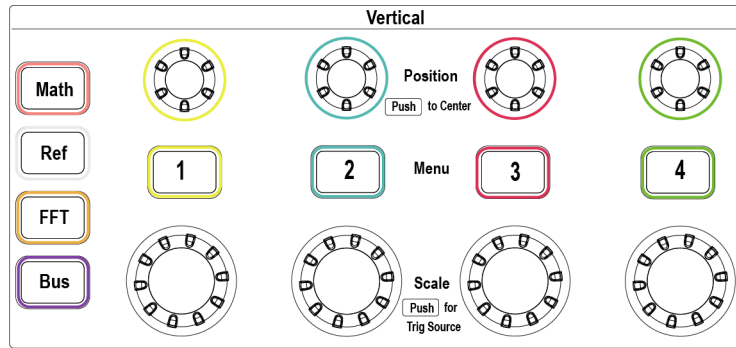

1525-27

The Vertical controls set the vertical settings (position and scale) for each channel, and enable turning on or off individual waveforms.

- The **Vertical Position** knob adjusts the vertical position for each channel's waveform.

Push the **Position** knob to move the waveform so that the ground reference level is on the center graticule of the screen.

---

**NOTE.** Push the **Fine** button (in **Navigation** controls) to let you make smaller adjustments with the knob.

---

- The Channel **1**, **2**, **3**, or **4** Menu buttons open (signal coupling, bandwidth, probe attenuation and type) the side menu where you can set the vertical parameters for each channel ( including signal coupling, bandwidth, probe attenuation, and probe type), or to display or remove that channel's waveform from the display. See [Setting channel input parameters](#) on page 47. See [Displaying and removing a waveform](#) on page 81.
- The Vertical **Scale** knob sets the vertical scale (volts or units per vertical graticule division) for each channel.

---

**NOTE.** Push the **Fine** button (in **Navigation** controls) to let you make smaller adjustments with the knob.

---

- The **Math** button opens the side menu where you can set the parameters to create and display a math waveform, or to display or remove the Math channel waveform from the display. See [Creating math waveforms](#) on page 110.
- The **Ref** button opens the side menu with controls to display or remove a reference waveform from the screen. See [Displaying reference waveforms](#) on page 120. See [Recalling waveform data](#) on page 136.
- The **FFT** button opens the FFT screen and shows side menu where you can set the **FFT** display parameters. See [Using FFT to see signal frequency information](#) on page 112.

## The Resources controls

The **Resources** controls contain the menus to select automatic measurements, save and recall files from internal memory and external USB drive, reset the oscilloscope to a default setting, and configure system parameters such as the oscilloscope user interface language, time and date, network settings, and much more.

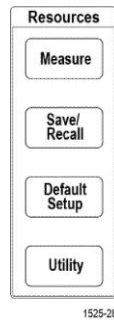

The **Measure** button opens a menu of automated measurements from which to select and display. See [Taking automatic measurements](#) on page 89.

The **Save/Recall** button opens the side menu where you can set how to save and recall data. You can save screen images to external files, and save and recall waveform data and oscilloscope settings, to and from internal memory or external files. See [Recalling data](#) on page 135.

The **Default Setup** button immediately restores the oscilloscope settings (horizontal, vertical, scale, position, and so on) to the factory default settings. You can use the side menu item to undo the default setting action. See [Setting the oscilloscope to factory default values - Default Setup](#) on page 80.

The **Utility** button opens the side menu where you can configure system settings such as user oscilloscope language, date and time, and connectivity (Wi-Fi, LAN, Ethernet), load new oscilloscope software, and so on. The **Utility** button also provides controls to access and manage files on a connected USB drive. See [Using the USB file utility functions](#) on page 139.

## Other front-panel controls



- The **Help** button opens a side menu where you can access the Tektronix Courseware lab exercise functions. See [Courseware on-instrument education and training](#) on page 168 and **Help Everywhere** on-screen settings and measurements help (See [Getting on-screen help for settings - Help Everywhere](#) on page 33.)
- The **Function** button opens a side menu where you can select optional analysis functions (when available with future software), the **Scope Intro** oscilloscope theory and feature tour (See [The Scope Intro function](#) on page 36).
- The **Autoset** button automatically sets the vertical, horizontal, and trigger controls to acquire and display a usable, stable waveform.
- The **Single** button takes a single waveform acquisition record.

---

**NOTE.** Pushing **Single** stops the oscilloscope continuous signal acquisition mode.

---

- The **Run/Stop** button toggles the oscilloscope between continuously acquiring waveforms (**Run**) and stopping all waveform acquisitions (**Stop**).
- The **File Save** button (located above the side menu buttons) performs an immediate preset save operation. Use the **Save/Recall** menu to set the save action to perform when the save button is pushed.
- The **Menu On/Off** button (located below the side menu buttons) clears displayed menus from the screen. This button also turns on and off the display of the measurements readouts and the FFT signal settings.



**Using the menu system** This topic introduces you to the TBS2000B menu system.

1. Push a front-panel menu button to display the menu that you want to use.

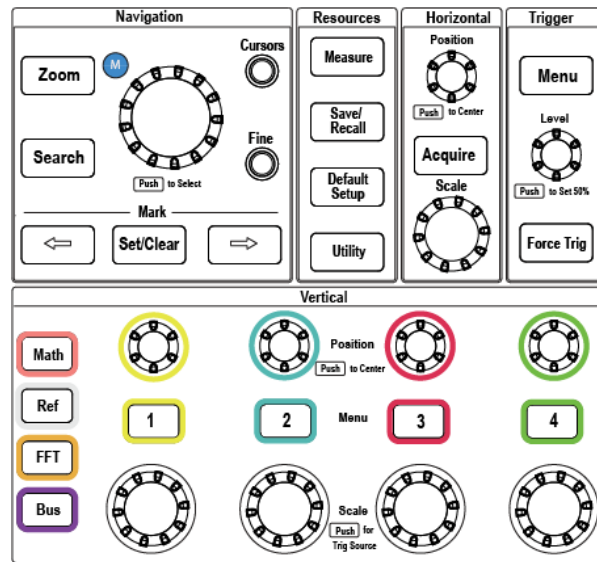

1525-30

The oscilloscope opens the side menu list for that button on the right side of the screen.

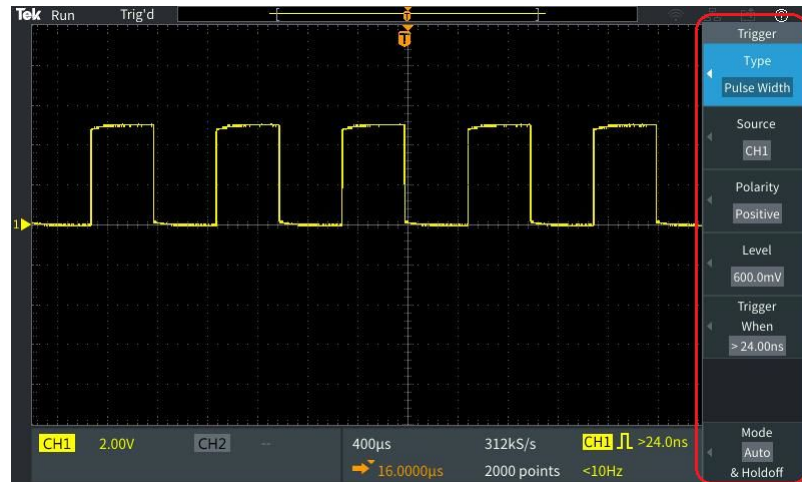

2. Push a side-menu button to select the on-screen menu item that is next to that button.

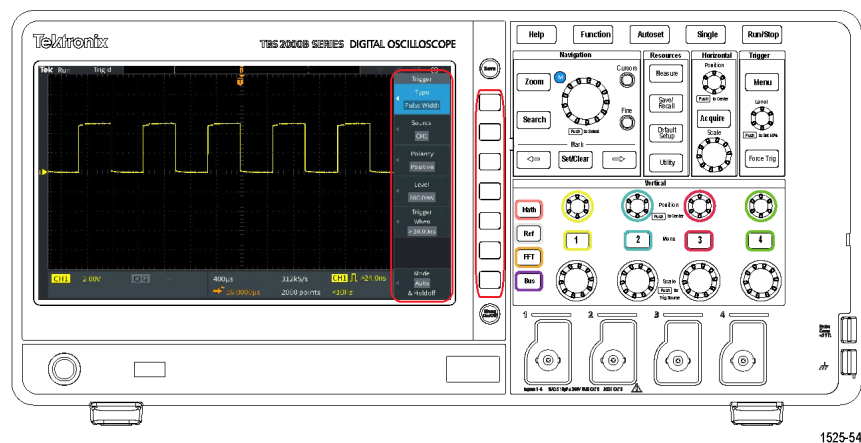

3. If the selected side menu item opens another menu, use the **Multipurpose** knob to highlight an item in the pop-out menu.

- When the item is highlighted, click the **Multipurpose** knob to enter that item and set the oscilloscope.

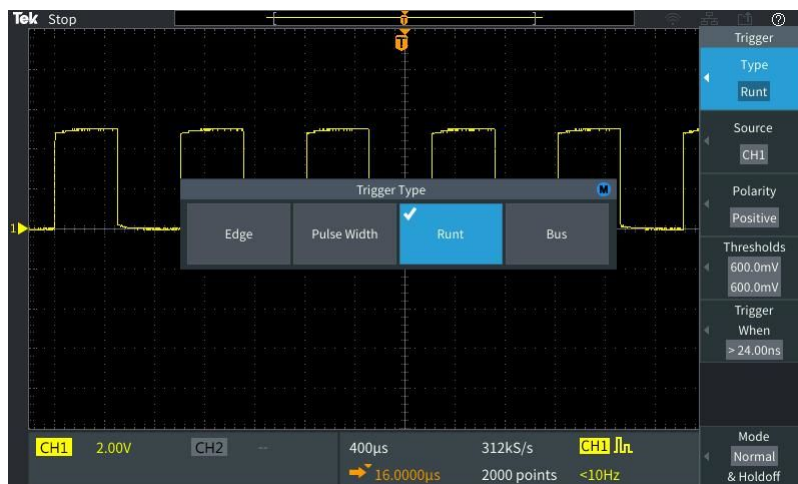

- Push the **Menu On/Off** to close menus, messages, and other on-screen items.

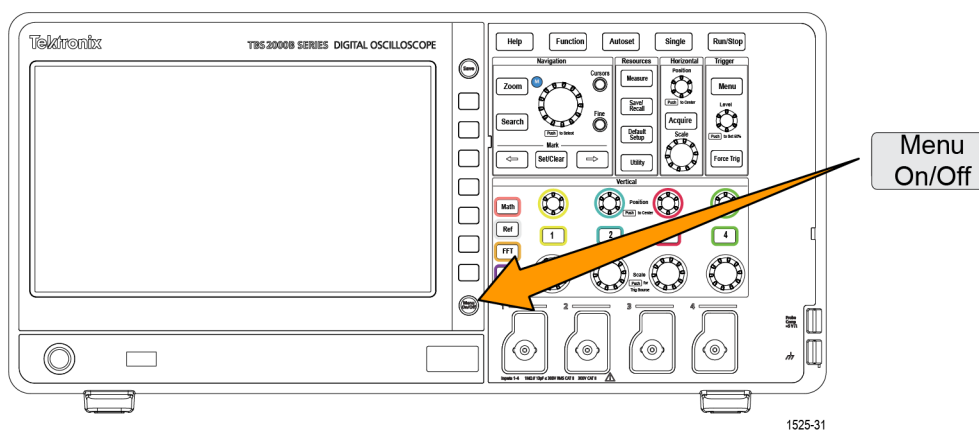

- Certain menu choices require you to set a numeric value to complete the setup. Use the **Multipurpose** knob and side-menu buttons to highlight, select, and adjust those settings.
- Push **Fine** to turn off or on the ability to make smaller adjustments with the **Multipurpose** knob. **Fine** works with the **Multipurpose** knob, Horizontal and Vertical **Position** knobs, Vertical **Scale** knob, and the Trigger **Level** knob.

The following topics provide hands-on experience with using the menu system:

See

- [Changing the user interface language](#) on page 15.
- [Changing the date and time](#) on page 19.
- [Doing a functional check](#) on page 24.

### Front-panel connectors

1. Channel 1, 2, (3, 4). Channel inputs with TekVPI Versatile Probe Interface.

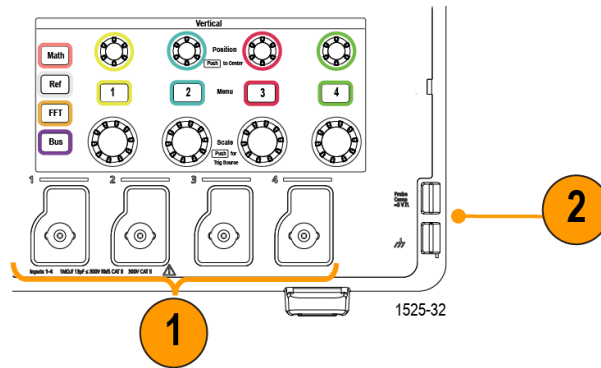

2. **PROBE COMP.** A square wave signal source and ground connection used to compensate probes.

Output voltage: ~ 5 V at ~1 kHz

Ground reference to which to connect the probe ground lead.

See [Compensating a passive voltage probe](#) on page 28.

3. USB 2.0 Host port.

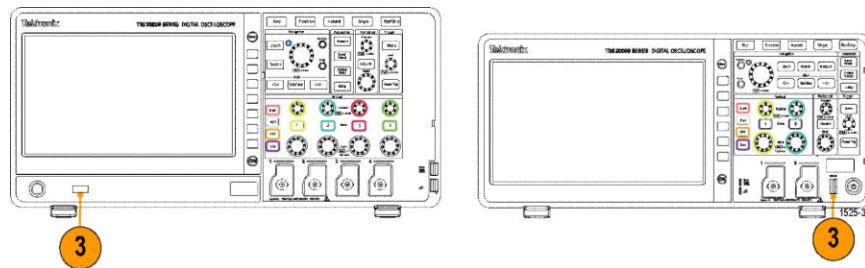

## Rear-panel connectors

1. **Aux Out.** Sends a negative pulse (high-to-low transition) when a trigger occurs, to synchronize other test equipment to trigger events.

---

**NOTE.** The Aux Out sends out a trigger signal from the last active channel as long as the signal it was triggering on is still connected, even if that channel is turned off.

---



---

**NOTE.** The Aux Out sends out random pulses when there are no signals connected to the oscilloscope.

---

2. **LAN.** Connects to a 10/100 Base-T local area network for file or printer access.

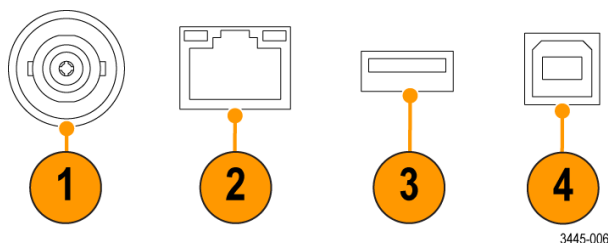

3. **USB 2.0 Host port.** A standard USB host port which lets you connect a USB Wi-Fi transceiver adapter (dongle) for wireless connectivity (A Tektronix TBS2000B series exclusive feature), or to USB flash drives with which to save or recall waveforms, settings, screen images, and Courseware education packages.
4. **USB 2.0 Device port.** Use the USB 2.0 Full Speed Device port to connect to a PC for remote control.

---

**NOTE.** The cable connected from the USB 2.0 Device port to the host computer must meet the USB2.0 specification for high speed operation when connected to a high speed host controller.

---

## The graphical user interface elements

The figures displayed below appear on the screen. Not all of these figures are visible at any given time. Some readouts move outside the graticule area when menus are turned off.

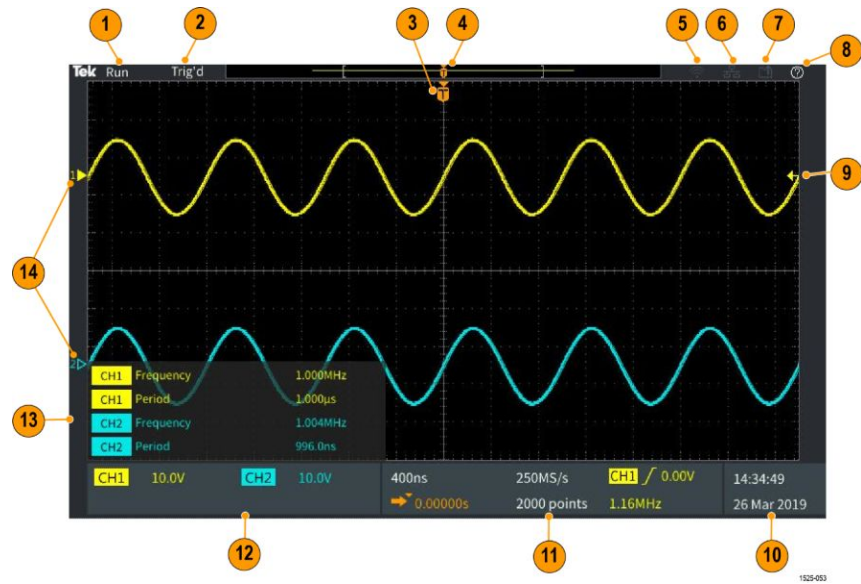

1. The acquisition status shows when an acquisition is running, stopped, or when acquisition preview is in effect. The acquisition modes are:
  - **Run:** The oscilloscope is acquiring and displaying waveforms.
  - **Stop:** The oscilloscope has stopped acquiring data.
  - **Roll:** It scrolls sequential waveform points across the display in a right-to-left rolling motion. Roll mode starts automatically when the timebase is set to  $\geq 40$  ms/div.

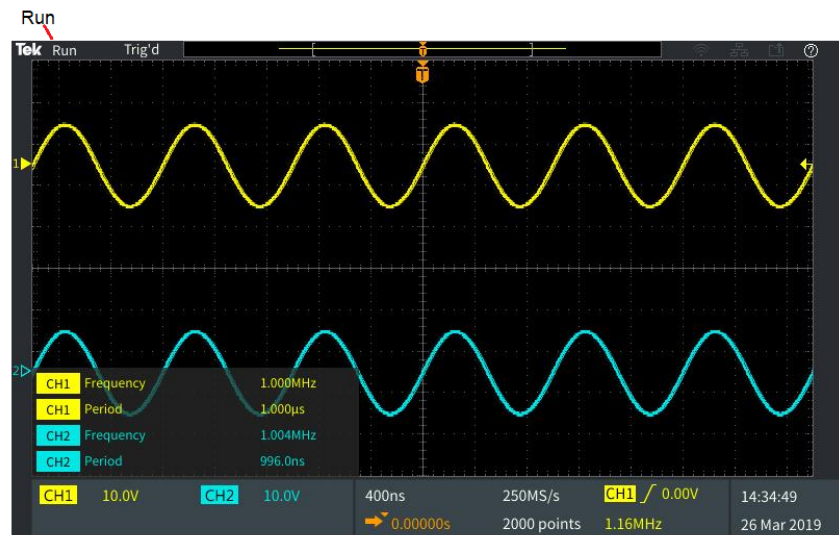

2. PreVu: The oscilloscope is stopped and you have used the **Horizontal** or **Vertical Scale** or **Position** knobs to change setting(s). In PreVu mode the oscilloscope is showing a “preview” of what the next acquisition might look like with the changed position or scale settings, based on the last acquired waveform, and assuming that the same signal is acquired with the new settings.

In other words, in PreVu mode the oscilloscope is reinterpreting the static waveform record of the last acquisition in memory, resulting in a displayed waveform that may not be accurate.

Do not use the **Horizontal** or **Vertical Scale** or **Position** knobs to examine a stopped or single-acquired waveform; instead, use the **Zoom** controls and **Multipurpose** knob.

The trigger status readout shows the trigger conditions:

- **Trig'd:** Triggered
- **Auto:** Acquiring untriggered data
- **PrTrig:** Acquiring pretrigger data
- **Trig?:** Waiting for trigger

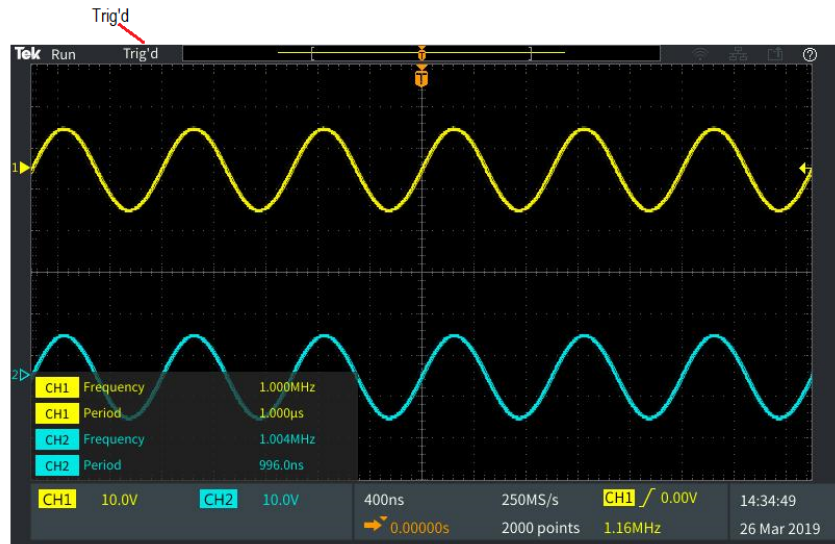

3. The trigger position icon (T) shows where the trigger occurred in the waveform record.

The expansion point icon (the orange ▼ triangle at the top of the T) shows the center point around which the horizontal scale control expands or shrinks the waveform (the center expansion point).

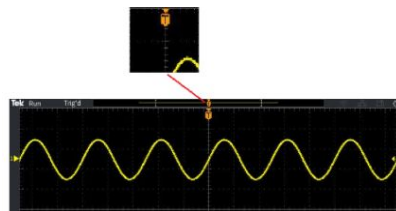

4. The waveform record view shows the trigger location relative to the entire waveform record. The line color corresponds to the selected waveform color. The area in brackets is the part of the waveform record that is displayed on the screen.





5. The Wi-Fi icon indicates when a Wi-Fi transceiver dongle is connected to the oscilloscope.



6. The Network icon indicates when the oscilloscope is connected to a local area network (LAN).



7. The **File Save** icon indicates when the oscilloscope send a file to the USB drive.



8. The **Help Everywhere** icon indicates when the Help Everywhere function is enabled to display information on oscilloscope settings when you open a menu.



9. The trigger level icon shows the trigger level of the active (selected) waveform. Use the Trigger **Level** knob to adjust the trigger level. The trigger level value is shown in the horizontal and trigger readouts at the bottom of the screen.

The oscilloscope shows two trigger level icons when you are triggering on a runt waveform. The trigger level knob only controls the lower trigger threshold level when in runt trigger mode. Use the **Trigger Menu** to set both trigger levels.



10. The Time and Date readout shows the oscilloscope clock setting. See [Changing the date and time](#) on page 19.



11. The Horizontal and Trigger readouts show Trigger, horizontal scale, sample rate, trigger delay time, and record length information.

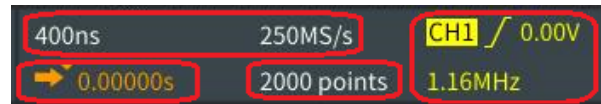

The **Trigger** readouts shows the trigger source, slope, and the trigger threshold level. The readout also shows the measured signal frequency. The trigger readouts for other trigger types show other values. The image shows the readouts for an **Edge** trigger.

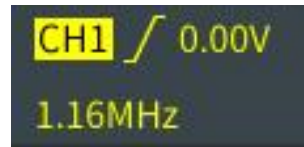

The **horizontal position/scale** readouts show the horizontal scale setting (time per major horizontal graticule division; adjust with the **Horizontal Scale** knob) and the sample rate (number of samples per second).

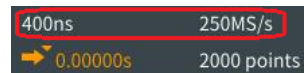

The trigger **Delay Mode** readout is the time from the T symbol to the expansion point icon (adjust with the **Horizontal Position** knob).

Use horizontal position to add delay between when the trigger occurs and when you actually capture the data. Insert a negative time to capture more waveform data before the trigger event.

When **Delay Mode** is off, this readout shows the time location of the trigger within the waveform record, as a percentage.

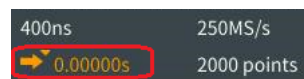

The **Record Length** readout shows how many samples are being stored for the current waveform records. See [Setting the record length](#) on page 77.



12. The **channel** readouts shows the channel scale factor (measurement units per major vertical graticule division), input signal coupling, signal invert status, and the oscilloscope bandwidth setting. Adjust these settings by using the **Vertical Scale** knob and the channel **1, 2, 3, or 4** menus.







13. The **measurement** readouts show the selected measurements. You can select up to six measurements to display at one time. See [Taking automatic measurements](#) on page 89.

Push the **Menu On/Off** button to toggle on off the display of the measurement readouts on the screen.



A  symbol appears next to a measurement if a vertical clipping condition exists. Clipping is when part of the waveform is above or below the display. Clipping can cause the oscilloscope to take inaccurate measurements. To obtain an accurate measurement, use the **Vertical Scale** and **Position** knobs to show all of the vertical range of the waveform on the screen.

CH1	Frequency	???	 Clipping positive
CH1	Period	???	 Clipping positive
CH2	Frequency	???	 Clipping positive
CH2	Period	???	 Clipping positive

- The waveform baseline indicator (left side of the screen) shows the zero-volt level of a waveform. The icon colors correspond to the waveform colors. Adjust waveform position with the **Vertical Position** knob.



### Labeling channels

You can add a label to the channels shown on the display for easy identification. The label is placed on the waveform baseline indicator in the left side of the screen. The label can have up to 32 characters. Perform the following steps to label a channel:

1. Push the front panel button for an input channel to open the associated side menu.
2. In the side menu, push **Label** to open the Label side menu.

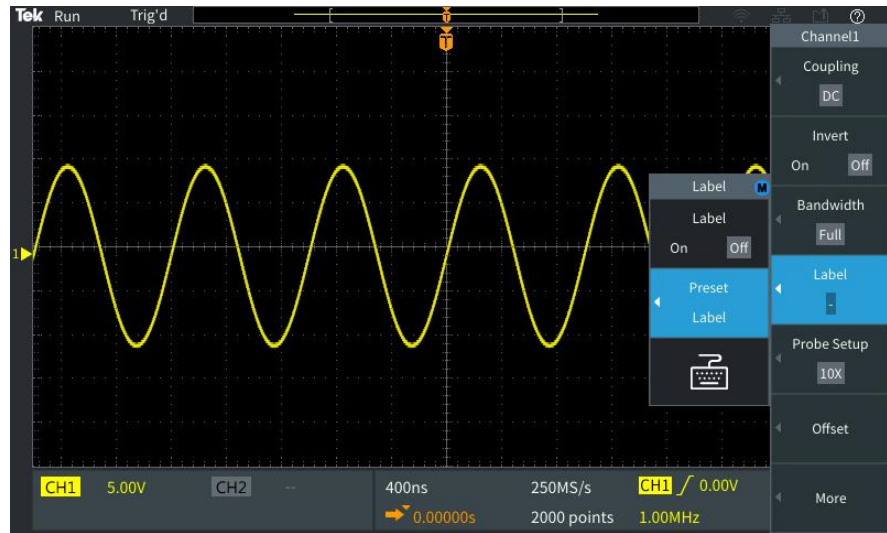

3. To turn the label text ON or OFF, use the **Multipurpose** knob to select **Label ON/OFF** and click the **Multipurpose** knob on the desired option.
4. Turn the **Multipurpose** knob to select **Preset Label**, and then click the knob to open the list of labels.

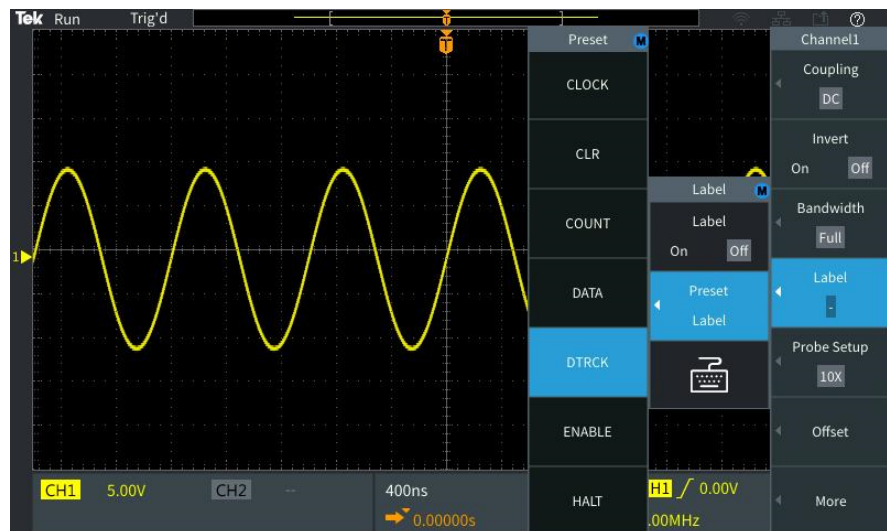

5. Turn the **Multipurpose** knob to scroll through the Preset list to find a suitable label. You can edit the label text after you insert it.
6. Push the **Multipurpose** knob to select the highlighted label. The selected label text will appear on the left side of the display. The example below shows the DTRCK label being selected and displayed.



7. Push the **Menu On/Off** button to close the Preset list.
8. If desired, edit the label text:
  - a. Turn the **Multipurpose** knob to select the keyboard icon in the Label side menu, and then click the **Multipurpose** knob to open the Label editor.
  - b. Push the **Backspace** side menu button to delete the existing label characters.
  - c. Turn the **Multipurpose** knob to highlight the first character in the label, and then click the Multipurpose knob to select the character. You can push the **A/a** and the **!/?** side menu buttons to toggle between different character sets.
  - d. Repeat step c as necessary to complete the label.
  - e. When you are done editing the label, push the **OK** side menu button to accept the label.

## Warranted specifications

See the *TBS2000B Specifications and Performance Verification Technical Reference Manual* (Tektronix part number 077-1538-xx), for the warranted specifications and performance verification procedure. This manual is English only, and can be downloaded from the Tektronix Web site ([www.tek.com/downloads](http://www.tek.com/downloads)).

## The default oscilloscope settings Default Setup

The following table lists the oscilloscope settings that are applied when you push the **Default Setup** button.

**NOTE.** When you push the **Default Setup** button, the oscilloscope displays the channel 1 waveform and removes all other waveforms.

Function	Setting and value
<b>Acquire</b>	Mode: <b>Sample</b> Record length: 2000 points
<b>Cursors</b>	Off Source: Ch1
Display	<b>Persist: Auto</b> Mode: YT <b>Backlight: 100%</b> <b>Graticule: On</b>
FFT	<b>Source wfm: On</b> Vertical Units: dBv RMS <b>Window: Hanning</b>
<b>Horizontal</b>	<b>Scale</b> (time per major horizontal division): 4.00 $\mu$ s/div <b>Delay: On</b> Trigger position: 0.00 s
<b>Math waveform</b>	<b>Source 1:</b> Ch1 <b>Source 2:</b> Ch2 <b>Operation:</b> + (add)
<b>Measurements</b>	<b>Source:</b> Ch1 Selected measurements: None
<b>Trigger</b>	<b>Type:</b> Edge <b>Source:</b> Ch1 <b>Coupling:</b> DC <b>Slope:</b> Rising <b>Level:</b> 0.00 V Mode: <b>Auto</b>



Function	Setting and value
USB Device Port	Connect to Computer
Vertical (all channels)	<b>Coupling: DC</b> <b>Invert: Off</b> <b>Bandwidth: Full</b> Voltage probe attenuation: 10X Baseline position: 0.00 V <b>Scale</b> (volts per major vertical division): 1.00 V

### Oscilloscope settings that are not reset by Default Setup

The Default Setup button does not reset or change the following settings:

- Language option
- Date and time
- Saved setups in memory
- Saved reference waveforms in memory
- Calibration data
- Network, Wi-Fi settings
- Probe setup (type and attenuation factor)
- Current save folder on the USB flash drive

## Physically securing the oscilloscope

Use a standard laptop security lock cable to attach your oscilloscope to your location.

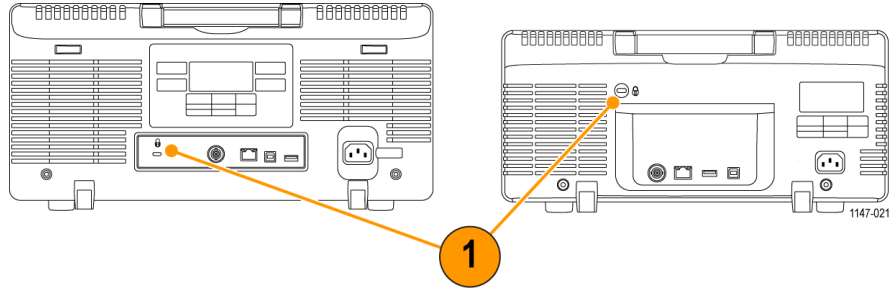

## Environmental considerations

This section provides information about the environmental impact of the product.

### Product end-of-life handling

Observe the following guidelines when recycling an instrument or component:

### Equipment recycling

Production of this equipment required the extraction and use of natural resources. The equipment may contain substances that could be harmful to the environment or human health if improperly handled at the product's end of life. To avoid release of such substances into the environment and to reduce the use of natural resources, we encourage you to recycle this product in an appropriate system that will ensure that most of the materials are reused or recycled appropriately.



This symbol indicates that this product complies with the applicable European Union requirements according to Directives 2012/19/EU and 2006/66/EC on waste electrical and electronic equipment (WEEE) and batteries. For information about recycling options, check the Tektronix Web site ([www.tek.com/productrecycling](http://www.tek.com/productrecycling)).

# Index

+Over measurement, 97

10X probe attenuation, 52

1X probe attenuation, 52

50  $\Omega$  BNC adapter, 3

## A

AC signal coupling, 47

Accessories

    optional, 2

    standard, 1

Acquire button, 174

Acquisition

    Average mode, 39

    definition, 38

    Hi Res mode, 39

    intervals, 38

    modes defined, 39

    peak detect mode, 39

    sample mode, 39

Acquisition mode, setting, 74

Adapter

    50  $\Omega$  BNC, 3

    GPIB to USB, 3

    TEK-USB-488, 3

Adding waveform to screen, 81

Adding waveforms (math), 110

Aliasing, FFT waveforms, 119

Altitude requirements, 11

Amplitude cursors, 103

Amplitude measurement, 96

Amplitude measurement descriptions, 96

Area measurement, 98

Area measurement descriptions, 98

Attenuation (probe), 51

Auto trigger mode, 45, 65

Automatic file names, 146

Automatic measurements, selecting, 89

Autoset

    change the password, 71

    tips, 69

    waveform position, 69

Autoset button, 25, 178

Autoset Enable button, 70

Available documents, 3

Average acquisition mode, 39, 74

## B

Backlight intensity, setting, 87

Bandwidth, models, 9

Bandwidth, setting, 49

Before Installation, 1

Blackman-Harris FFT window, 118

BMP screen image format, 130

Burst Width measurement, 94

Buttons

    Acquire, 174

    Autoset, 25

    Autoset button, 178

    Channel Menu, 176

    Courseware, 178

    Cursors, 172

    Default Setup, 177

    F (FFT), 176

    Force Trig, 175

    Function, 178

    M (Math), 176

    Measure, 177

    Menu On/Off, 178

    R (Ref), 176

    Run/Stop, 178

    Save/Recall, 177

    Single, 178

    Trigger Menu, 175

    Utility, 177

## C

Calibration, 32

Calibration certificate, 1

Carry case, hard, 3

Carry case, soft, 3

Change file save location (USB), 141

- Change Folder (file utility), 141
  - Change Folder rules, 141
  - Change the date and time, 19
  - Changing the UI language, 15
  - Channel deskew, setting, 57
  - Channel input parameters, setting, 47
  - Channel labeling, 192
  - Channel Menu buttons, 176
  - Clipping, signal, 90
  - Compensate a passive probe, 28
  - Compensate signal path (SPC), 32
  - Concepts
    - acquisition, 38
    - acquisition intervals, 38
    - acquisition modes, 39
    - Amplitude-related measurements, 96
    - Area-related measurements, 98
    - Auto trigger mode, 45
    - automatic file names, 146
    - bandwidth, 49
    - cursors, 103
    - DC coupling, 45
    - FFT waveform aliasing, 119
    - FFT windows, 116
    - file utility user interface, 139
    - Frequency-related measurements, 92
    - gating, 99
    - HF coupling, 45
    - Holdoff trigger mode, 46
    - LF coupling, 45
    - Noise reject coupling, 45
    - Normal trigger mode, 45
    - posttrigger, 41
    - pretrigger, 41
    - probe attenuation, 51
    - roll mode, 78
    - sampling oscilloscope, 37
    - Time-related measurements, 94
    - trigger coupling, 45
    - trigger delay (acquisition mode), 46
    - trigger Holdoff mode, 46
    - trigger level, 42
    - trigger modes, 45
    - trigger slope, 42
    - trigger threshold, 42
    - trigger types, 44
    - waveform persistence, 82
    - XY display, 85
    - Zoom, 121
  - Confidential data, erasing, 147
  - Connecting to a computer, 163
  - Connectors
    - probe compensation, 182
  - Controls
    - Horizontal, 174
    - other front-panel buttons, 177
    - Resources, 177
    - Trigger, 175
    - Vertical, 176
  - Coupling (edge trigger), 60
  - Courseware
    - create a report, 172
    - file content info, 169
    - load a course file, 169
    - overview, 168
    - running courseware labs, 170
    - saving results (report), 172
  - Courseware button, 178
  - Create a new folder (USB drive), 142
  - CSV format (waveform data), 131
  - Cursors, 103
  - Cursors button, 172
  - Cycle Area measurement, 98
  - Cycle Mean measurement, 98
  - Cycle RMS measurement, 98
- ## D
- Data, waveform (saving), 130
  - Date and time, changing, 19
  - DC coupling (trigger), 45
  - DC signal coupling, 47
  - Decay, waveform, 82
  - Default oscilloscope settings, 194
  - Default Setup, 80
  - Default Setup button
    - button, 177
  - Delay (trigger, acquisition mode), 46

- Delay time (trigger), 46
- Delay time readout, 189
- DelayFF measurement, 94
- DelayFR measurement, 94
- DelayRF measurement, 94
- DelayRR measurement, 94
- Deleting files or folders (USB drive), 143
- Deskew, setting, 57
- Determining channel of saved ISF file, 146
- DHCP IP address, 154
- DHCP on/off, 156
- DHCP on/off (Wi-Fi), 161
- Disable cursor button, 107
- Disable USB Device port, 150
- Display
  - set backlight intensity, 87
  - user interface elements, 184
  - waveform aliasing, FFT, 119
  - waveform decay (persistence), 82
  - waveform persistence, 82
  - XY mode, 85
- Dual waveform math, 110
- E**
- Edge trigger, defined, 44
- Edge trigger, selecting, 60
- Electrostatic damage, preventing, 24
- Equipment recycling, 196
- Erase setup and ref memory, 147
- eScope oscilloscope browser page, 165
- Ethernet, 9
- Expansion point icon, 186
- F**
- F (FFT) button, 176
- Factory default settings, 194
- Factory settings, loading, 80
- Fall Time measurement, 94
- Falling Edge Count measurement, 92
- Feature Enable
  - disable, 70, 107
- FFT
  - Blackman-Harris window, 118
  - Hamming window, 118
  - Hanning window, 118
  - Rectangular window, 118
  - set FFT center position, 112
  - set FFT horizontal scale, 112
  - set FFT source wfm, 112
  - set FFT vertical units, 112
  - set FFT window type, 112
  - show FFT source wfm, 112
  - tips, 116
  - waveform aliasing, 119
  - window concepts, 116
- File formats, screen images, 130
- File naming rules, auto-created, 146
- File utility
  - change file save location (USB), 141
  - Change Folder, 141
  - controls, 139
  - create new folder, 142
  - deleting files or folders, 143
  - file naming rules, auto-created, 146
  - file save location rules, 141
  - formatting USB drive, 145
  - functions, 139
  - renaming files or folders, 144
  - save file location rules, 141
  - user interface, 139
- Firmware upgrade, 166
- For more information
  - performance verification, 194
  - specifications, 194
  - supported probes, 23
- Force Trig button, 175
- Formatting USB drive, 145
- Frequency, 93
- Frequency cursors, 103
- Frequency description, 92
- Frequency measurements descriptions, 92
- Front-panel language overlay, 18
- Front-panel overlays (languages), 2
- Function button, 178
- Functional check, 24

**G**

Gating (measurement), 99  
GPIB and USB, 150  
GPIB to USB adapter, 3  
Ground lead tip, probe, 31  
Ground signal coupling, 47  
Ground strap, 24  
Ground yourself to discharge static, 24

**H**

Hamming FFT window, 118  
Hanning FFT window, 118  
HelpEverywhere feature, 33  
HF coupling (trigger), 45  
Hi Res acquisition mode, 39  
High measurement, 97  
Holdoff trigger mode, 46, 65  
Horiz center position (FFT), 112  
Horizontal controls, 174  
Horizontal position knob, 174  
Horizontal scale (FFT), 112  
Horizontal scale knob, 174  
How to

- access remotely from Web browser (eScope), 165
- add a waveform to the screen, 81
- Add waveforms (math), 110
- Average acquisition mode, 74
- bring cursors on-screen, 103
- change a menu field value, 19
- change Autoset password, 71
- change the language, 15
- change the time and date, 19
- check that oscilloscope is working, 24
- close menus, 15, 19
- compensate a passive probe, 28
- compensate internal signal paths (SPC), 32
- configure Wi-Fi, 157
- connect probes, 22
- create math waveforms, 110
- create new folder (USB drive), 142
- delete files or folders, 143

disable Autoset button, 70  
disable cursor button, 107  
disable USB Device port, 150  
enable HelpEverywhere, 33  
erase oscilloscope memory, 147  
examine waveform details (zoom), 121  
find information on supported probes, 23  
format USB drive, 145  
install language overlay, 18  
install new firmware, 166  
invert the input signal, 48  
link cursors, 103  
load a courseware file, 169  
load factory settings, 80  
load oscilloscope setups, 135  
load waveform files, 136  
move a waveform (vertical), 55  
move both cursors at same time, 103  
move cursors onto screen, 103  
Multiply waveforms (math), 110  
open reference waveforms, 120  
perform a functional check, 24  
power off the oscilloscope, 13  
prevent electrostatic damage, 24  
quickly set 1X, 10X attenuation, 52  
recall oscilloscope setups, 135  
recall waveform data, 136  
recall waveform files, 136  
remove a waveform from the screen, 81  
rename files or folders, 144  
restore default settings, 80  
restore factory settings, 80  
run courseware labs, 170  
Run SPC, 32  
save courseware lab results (report), 172  
save oscilloscope setups, 132  
save screen to a USB drive, 129  
save waveform data, 130  
select a measurement, example, 26  
select automatic measurements, 89  
select cursors, 103  
select device for USB port, 149  
select slope (edge trigger), 65

- set acquisition mode, 74
  - set backlight intensity, 87
  - set bandwidth, 49
  - set channel deskew, 57
  - set DC offset on a signal, 54
  - set default save location (Change Folder), 141
  - set Edge trigger, 60
  - set FFT center position, 112
  - set FFT horizontal scale, 112
  - set FFT source wfm, 112
  - set FFT vertical units, 112
  - set FFT window type, 112
  - set Hi Res acquisition mode, 74
  - set input signal coupling, 47
  - set IP address, 154
  - set IP address (nonDHCP), 155
  - set measure current (for voltage probe), 53
  - set measurement gating, 99
  - set Peak Detect acquisition mode, 74
  - set probe attenuation, 51
  - set probe type (voltage, current), 50
  - set pulse width trigger, 62
  - set record length, 77
  - set runt pulse trigger, 63
  - set Sample acquisition mode, 74
  - set Save File button, 133
  - set signal DC offset, 54
  - set slope (edge trigger), 60
  - set the date and time, 19
  - set the language, 15
  - set trigger coupling (edge trigger), 60
  - set trigger holdoff, 65
  - set trigger modes, 65
  - set trigger source, 60, 62, 63
  - set trigger when condition (pulse width), 62
  - set trigger when condition (runt pulse), 63
  - set vertical offset, 54
  - set vertical position, 55
  - set waveform decay time, 82
  - set waveform persistence, 82
  - set Wi-Fi parameters, 157
  - show a snapshot of all measurements, 91
  - show FFT source wfm, 112
  - show help on menu items, 33
  - show measurements, 89
  - show reference waveforms, 120
  - start acquiring a signal, 73
  - stop acquiring a signal, 73
  - Subtract waveforms (math), 110
  - take and save a screenshot, 129
  - take automatic measurements, 89
  - take measurement snapshot, 91
  - take measurements with cursors, 103
  - turn DHCP on/off, 156
  - turn DHCP on/off (Wi-Fi), 161
  - turn Wi-Fi on/off, 157
  - turn XY display on/off, 85
  - undo an Autoset, 67
  - undo default settings, 80
  - upgrade the firmware, 166
  - use Autoset, 67
  - use built-in oscilloscope browser (eScope), 165
  - use cursors, 103
  - use roll mode, 78
  - use the menu system, 15, 19, 179
  - use the Multipurpose knob, 15, 16, 19
  - use the side-menu buttons, 15, 19
  - use Zoom, 121
  - view available Wi-Fi networks, 158
  - view IP address, 153
  - view oscilloscope theory and concepts, 36
  - view USBTMC information, 150
  - view Wi-Fi settings, 158
  - zoom on waveforms, 121
- Humidity requirements, 11
- I**
- Icon
    - Expansion point, 186
    - measurement clipping, 191
    - Trigger level, 186
    - Trigger position, 186
  - Image file formats, 130
  - Infinite persistence (waveform), 82
  - Installing firmware, 166
  - Invert input signal, 48

IP address, show, 153  
ISF format (waveform data), 131

## J

JPG screen image format, 130

## K

### Knobs

- Horizontal position, 174
- Horizontal scale, 174
- Push for Trig Source, 176
- Push to Center, 176
- Push to Set 50%, 175
- Trigger Level, 175
- Vertical Position, 176
- Vertical Scale, 176

## L

Labeling channels, 192

### Language

- change the oscilloscope language, 15
- overlay, 18

Languages, 2

Level, trigger, 42

LF coupling (trigger), 45

Link cursors, 103

Lissajou pattern (XY mode), 85

### Loading

- Courseware file, 169
- setup files, 135
- waveform files, 136

Low measurement, 97

## M

M (Math) button, 176

### Manual

- performance verification, 3
- programmer, 3
- service, 3
- specifications, 3
- user, 3

Math waveforms, 110

Max measurement, 96

Mean measurement, 97

Measure button, 177

Measure Current mode (voltage probes), 53

Measurement clipping icon, 191

Measurement readouts, 190

### Measurements

- Over (Neg overshoot), 97

- +Over (Pos overshoot), 97

- Amplitude, 96

- Area, 98

- Burst Width, 94

- cursors, 103

- Cycle Area, 98

- Cycle Mean, 98

- Cycle RMS, 98

- defined, 92

- DelayFF, 94

- DelayFR, 94

- DelayRF, 94

- DelayRR, 94

- descriptions, 92

- Fall Time, 94

- Falling Edge Count, 92

- gating, 99

- High, 97

- Low, 97

- Max, 96

- Mean, 97

- Min, 97

- Negative Duty Cycle, 94

- Negative Pulse Count, 92

- Negative Pulse Width, 94

- Period, 94

- Phase, 94

- Pk-Pk, 96

- Positive Duty Cycle, 94

- Positive Pulse Count, 92

- Positive Pulse Width, 94

- readout, 89

- Rise Time, 94

- Rising Edge Count, 92

- RMS, 98



- selecting, 89
- signal clipping and measurements, 90
- snapshot of all measurements, 91
- turning off readout, 89
- unselecting, 89
- Memory, erasure of, 147
- Menu On/Off button, 178
- Menu system, using, 179
- Menu system, using (example), 15, 19, 24
- Min measurement, 97
- Mode, roll, 78
- Modes, trigger (selecting), 65
- Moving the waveform vertical position, 55
- MPK (Multipurpose) knob, 15
- Multiplying waveforms (math), 110
- Multipurpose (MPK) knob, 15
- Multipurpose knob, 16

## N

- Negative Duty Cycle measurement, 94
- Negative Overshoot measurement, 97
- Negative Pulse Count measurement, 92
- Negative Pulse Width measurement, 94
- No course files found error message, 170
- Noise reject coupling (trigger), 45
- nonDHCP IP address, 155
- Normal trigger mode, 45, 65

## O

- Operating environment requirements, 11
- Optional accessories, 2
- Oscilloscope settings, default, 194
- Overview of oscilloscope theory, 36

## P

- Password, Autoset, 71
- Peak Detect acquisition mode, 39, 74
- Performance verification, 194
- Performance verification manual, 3
- Period measurement, 94
- Persistence, waveform, 82
- Phase measurement, 94

- Pk-Pk measurement, 96
- PNG screen image for mat, 130
- Positive Duty Cycle measurement, 94
- Positive Overshoot measurement, 97
- Positive Pulse Count measurement, 92
- Positive Pulse Width measurement, 94
- Posttrigger, concept, 41
- Power
  - cord, 1
  - off, 13
  - removing, 13
- Power requirements
  - consumption, 11
  - frequency, 11
  - voltage, 11
- Pretrigger, concept, 41
- Preventing electrostatic damage, 24
- Probe Comp, 25
- PROBE COMP connector, 182
- Probe compensation, 28
- Probes
  - attenuation, 52
  - connecting, 22
  - probe type (voltage, current), 50
  - set measure current mode, 53
  - setting attenuation, 51
  - supported, 23
  - supported TekVPI probes, 3
  - TekVPI, 22
  - types, 22
  - use shortest ground lead, 31
- Product end-of-life handling (recycling), 196
- Product manuals, 3
- Programmer manual, 3
- Pulse Width trigger, defined, 44
- Pulse width trigger, selecting, 62
- Push for Trig Source knob, 176
- Push to Center knob, 176
- Push to Set 50% knob, 175

## R

- R (Ref) button, 176
- Readouts

- automatic measurements, 89
- Cursors, 103
- measurement clipping, 191
- measurement snapshot, 91
- measurements, 190
- trigger delay time, 189
- Recalling
  - oscilloscope setups, 135
  - setup files, 135
  - waveform data, 136
  - waveform files, 136
- Record length
  - setting, 77
  - size limit for FFT waveforms, 112
  - size limit for reference memory, 77
- Rectangular FFT window, 118
- Recycling, oscilloscope, 196
- Reference
  - automatic file naming, 146
  - Courseware file content info, 169
  - CSV files, 131
  - default oscilloscope settings, 194
  - determining channel of saved ISF file, 146
  - factory default settings, 194
  - file naming rules, auto-created, 146
  - image file formats, 130
  - ISF files, 131
  - No course files found error message, 170
  - save file rules (file utility), 141
  - saved waveform files, 131
  - settings not changed by Default Setup, 195
- Reference memory and record length limit, 77
- Reference waveforms, showing, 120
- Related documents, 3
- Removing waveform from screen, 81
- Renaming files or folders (USB drive), 144
- Resources controls, 177
- Rise Time measurement, 94
- Rising Edge Count measurement, 92
- RMS measurement, 98
- Roll mode conditions, 78
- Rugged carry case, 3
- Run/Stop, 73
- Run/Stop button, 178
- Runt pulse trigger, selecting, 63
- Runt trigger, defined, 44
- S**
- Safety
  - AC ground connection, 11
  - power requirements, 11
- Sample acquisition mode, 39, 74
- Sample rates, 9
- Save File button, 133
- Save/Recall button, 177
- Saving
  - image file formats, 130
  - Save File button, 133
  - screen image to a USB drive, 129
  - set Save File button, 133
  - setups to a file or memory, 132
  - waveform data to file, 130
  - waveform to ref memory, 130
- Scale, horizontal, 174
- Scope Intro, 36
- Screen cursors, 103
- Screen image, saving to a file, 129
- Screenshot, taking, 129
- Securing memory, 147
- Select device for USB port, 149
- Service manual, 3
- Set IP address (DHCP), 154
- Set IP address (nonDHCP), 155
- Set the date and time, 19
- Settings not changed by Default Setup, 195
- Settings, saving to file or memory, 132
- Setup info, saving to file or memory, 132
- Setups, recalling, 135
- Showing help on menu items, 33
- Side-menu buttons, example, 15
- Signal clipping, 90
- Signal coupling, setting, 47
- Signal DC offset, setting, 54
- Signal path compensation (SPC), 32
- Signal source (FFT), 112
- Single acquisition, 73
- Single button, 178

Slope (edge trigger), 60  
 Slope, trigger, 42  
 Snapshot of all measurements, 91  
 Socket server, 163  
 SPC (signal path compensation), 32  
 Specifications, 194  
 Specifications manual, 3  
 Standard accessories, 1  
 Start an acquisition, 73  
 Stop an acquisition, 73  
 Subtracting waveforms (math), 110  
 Supported TekVPI probes, 3

## T

TBS2KB.TEK file, 166  
 TEK-USB-488 Adapter, 3  
 TekSecure, 147  
 TekVPI probes, 22  
 Temperature requirements, 11  
 Time cursors, 103  
 Time measurements descriptions, 94  
 Tips
 

- automatic file naming, 146
- Autoset, 69
- creating folders (USB drive), 143
- determining channel of saved ISF file, 146
- FFT, 116
- math waveform, 111
- No course files found error message, 170
- reference waveforms, 120
- renaming folders (USB drive), 145
- use shortest ground lead, 31
- XY display mode, 86

 Transit case, hard, 3  
 Transit case, soft, 3  
 Trigger
 

- Auto modes, 65
- Auto trigger mode, 45
- coupling (edge only), 60
- DC coupling, 45
- delay (acquisition mode), 46
- edge, 60
- Edge, defined, 44
- HF coupling, 45
- Holdoff mode, 46, 65
- level, 42
- level (edge), 60
- LF coupling, 45
- modes, 65
- Noise reject coupling, 45
- Normal mode, 65
- Normal trigger mode, 45
- polarity (pulse width), 62
- polarity (runt pulse), 63
- position icon, 186
- posttrigger, 41
- pretrigger, 41
- pulse width, 62
- Pulse Width, defined, 44
- runt pulse, 63
- Runt signal, defined, 44
- set holdoff, 65
- set holdoff to minimum, 65
- slope, 42
- slope (edge only), 60
- source, 60, 62, 63
- threshold (pulse width), 62
- thresholds (runt pulse), 63
- trigger delay readout, 189
- trigger level icon, 186
- trigger mode concepts, 45
- trigger types, 44
- trigger when (pulse width), 62
- trigger when (runt pulse), 63
- type (edge), 60
- type (pulse width), 62, 63

 Trigger controls, 175  
 Trigger Level knob, 175  
 Trigger Menu button, 175  
 Turn DHCP on/off, 156  
 Turn DHCP on/off (Wi-Fi), 161

## U

Undo Autoset, 67  
 Undo Default Setup, 80

Upgrading firmware, 166  
USB  
    Device port, 9  
    Host port, 9  
USB Wi-Fi option, 3  
Using the menu system, 179  
Utility button  
    menu, 177

## V

Variable persistence (waveform), 82  
Versatile Probe Interface (TekVPI), 22  
Vertical  
    position and autose, 69  
Vertical controls, 176  
Vertical offset, setting, 54  
Vertical Position knob, 176  
Vertical position, setting, 55  
Vertical Scale knob, 176  
Vertical units (FFT), 112  
View IP address, 153  
View USBTMC information, 150

## W

Waveform  
    adding to screen, 81  
    data formats (CSV, ISF), 131

    decay time (persistence), 82  
    display a waveform, 81  
    FFT waveforms, 112  
    file formats (CSV, ISF), 131  
    loading from file or memory, 136  
    math waveforms, 110  
    persistence time, 82  
    recalling from file or memory, 136  
    remove a waveform, 81  
    removing from screen, 81  
    saving to file or ref, 130  
Waveform aliasing, FFT, 119  
Waveform DC offset, 54  
Waveform vertical position, 55  
Web-based remote access (eScope), 165  
Wi-Fi  
    listing available networks, 158  
    set parameters, 157  
    turn DHCP on/off, 161  
    turn on/off, 157  
    view settings, 158  
    viewing available networks, 158  
Window type (FFT), 112

## Z

Zoom, 121